

PANTUM

WWW.PANTUM.COM

Pantum M7650 Series

Monochrome laser multifunction printer



It is recommended that you read this Guide carefully before using the printer

Contents

- Safety information.....7**
 - Conventions.....7
 - Product statements.....7

- Learning about the printer..... 10**
 - Selecting a location for the printer..... 10
 - Printer configurations..... 11
 - Attaching cables..... 12
 - Using the control panel.....14
 - Understanding the status of the power button and indicator light..... 14
 - Using the home screen.....15
 - Printing the Network Setup Page.....16

- Setting up and using the home screen applications..... 17**
 - Customizing the home screen..... 17
 - Setting up Card Copy..... 17
 - Using Shortcut Center..... 17
 - Using Display Customization.....18
 - Setting up Scan Center..... 18
 - Managing contacts..... 18

- Setting up and using the accessibility features..... 21**
 - Enabling Magnification mode.....21
 - Activating Voice Guidance..... 21
 - Adjusting the Voice Guidance speech rate..... 21
 - Enabling spoken passwords or personal identification numbers..... 21
 - Navigating the screen using gestures..... 22
 - Using the keyboard on the display..... 22

- Loading paper and specialty media..... 23**
 - Setting the size and type of the specialty media..... 23
 - Configuring Universal paper settings..... 23
 - Loading trays..... 23
 - Loading the multipurpose feeder..... 25
 - Linking trays.....26

Supported paper.....	27
Supported paper sizes.....	27
Supported paper types.....	29
Supported paper weights.....	29
Printing.....	30
Printing from a computer.....	30
Printing from a mobile device.....	30
Printing from a flash drive.....	31
Supported flash drives and file types.....	32
Configuring confidential jobs.....	33
Printing held jobs.....	33
Printing a font sample list.....	33
Canceling a print job.....	34
Copying.....	35
Making copies.....	35
Copying photos.....	35
Copying on letterhead.....	35
Copying on both sides of the paper (two-sided).....	35
Reducing or enlarging copies.....	36
Collating copies.....	36
Placing separator sheets between copies.....	36
Copying multiple pages onto a single sheet.....	36
Creating a copy shortcut.....	36
E-mailing.....	37
Setting up the e-mail function.....	37
Configuring e-mail settings.....	37
Sending an e-mail.....	37
Creating an e-mail shortcut.....	38
Faxing.....	39
Setting up the printer to fax.....	39
Sending a fax.....	44
Scheduling a fax.....	45
Creating a fax destination shortcut.....	45

Changing the fax resolution..... 45
Adjusting the fax darkness..... 45
Viewing a fax log..... 46
Blocking junk faxes..... 46
Holding faxes..... 46
Forwarding a fax..... 46

Scanning..... 47

Scanning to an FTP server..... 47
Creating an FTP shortcut..... 47
Scanning to a flash drive..... 47
Sending scanned documents to a computer..... 48

Understanding the printer menus..... 49

Menu map..... 49
Device..... 50
Print..... 61
Paper..... 69
Copy..... 72
Fax..... 75
E-mail..... 88
FTP..... 95
Network/Ports..... 99
USB Drive..... 111
Security..... 117
Reports..... 125
Help..... 126
Troubleshooting..... 126
Printing the Menu Settings Page..... 127

Securing the printer..... 128

Locating the security slot..... 128
Erasing printer memory..... 128
Erasing printer hard disk memory..... 128
Encrypting the printer hard disk..... 129
Restoring factory default settings..... 129
Statement of Volatility..... 129

Maintaining the printer.....	131
Adjusting the speaker volume.....	131
Networking.....	131
Cleaning printer parts.....	133
Ordering parts and supplies.....	137
Replacing parts and supplies.....	137
Moving the printer.....	148
Saving energy and paper.....	149
Clearing jams.....	151
Avoiding jams.....	151
Identifying jam locations.....	152
Paper jam in door A.....	153
Paper jam in the rear door.....	157
Paper jam in the standard bin.....	158
Paper jam in the duplex unit.....	159
Paper jam in trays.....	160
Paper jam in the multipurpose feeder.....	161
Paper jam in the automatic document feeder.....	162
Troubleshooting.....	163
Network connection problems.....	163
Internal option problems.....	165
Issues with supplies.....	166
Paper feed problems.....	166
Printing problems.....	169
Faxing problems.....	197
Scanning problems.....	200
Contacting customer support.....	204
Upgrading and migrating.....	205
Hardware.....	205
Software.....	209
Firmware.....	211

Notices.....212

Index..... 216

Safety information





Conventions

Note: A *note* identifies information that could help you.







Warning: A *warning* identifies something that could damage the product hardware or software.

CAUTION: A *caution* indicates a potentially hazardous situation that could injure you.

Different types of caution statements include:

-  **CAUTION—POTENTIAL INJURY:** Indicates a risk of injury.
-  **CAUTION—SHOCK HAZARD:** Indicates a risk of electrical shock.
-  **CAUTION—HOT SURFACE:** Indicates a risk of burn if touched.
-  **CAUTION—TIPPING HAZARD:** Indicates a crush hazard.
-  **CAUTION—PINCH HAZARD:** Indicates a risk of being caught between moving parts.

Product statements

-  **CAUTION—POTENTIAL INJURY:** To avoid the risk of fire or electrical shock, connect the power cord to an appropriately rated and properly grounded electrical outlet that is near the product and easily accessible.
-  **CAUTION—POTENTIAL INJURY:** To avoid the risk of fire or electrical shock, use only the power cord provided with this product or the manufacturer's authorized replacement.
-  **CAUTION—POTENTIAL INJURY:** Do not use this product with extension cords, multioutlet power strips, multioutlet extenders, or UPS devices. The power capacity of these types of accessories can be easily overloaded by a laser printer and may result in a risk of fire, property damage, or poor printer performance.
-  **CAUTION—POTENTIAL INJURY:** Do not use this product with an inline surge protector. The use of a surge protection device may result in a risk of fire, property damage, or poor printer performance.
-  **CAUTION—POTENTIAL INJURY:** To reduce the risk of fire, use only a 26 AWG or larger telecommunications (RJ-11) cord when connecting this product to the public switched telephone network. For users in Australia, the cord must be approved by the Australian Communications and Media Authority.
-  **CAUTION—SHOCK HAZARD:** To avoid the risk of electrical shock, do not place or use this product near water or wet locations.
-  **CAUTION—SHOCK HAZARD:** To avoid the risk of electrical shock, do not set up this product or make any electrical or cabling connections, such as the power cord, fax feature, or telephone, during a lightning storm.

 **CAUTION—POTENTIAL INJURY:** Do not cut, twist, bind, crush, or place heavy objects on the power cord. Do not subject the power cord to abrasion or stress. Do not pinch the power cord between objects such as furniture and walls. If any of these things happen, a risk of fire or electrical shock results. Inspect the power cord regularly for signs of such problems. Remove the power cord from the electrical outlet before inspecting it.

 **CAUTION—SHOCK HAZARD:** To avoid the risk of electrical shock, make sure that all external connections (such as Ethernet and telephone system connections) are properly installed in their marked plug-in ports.

 **CAUTION—SHOCK HAZARD:** To avoid the risk of electrical shock, if you are accessing the controller board or installing optional hardware or memory devices sometime after setting up the printer, then turn the printer off, and unplug the power cord from the electrical outlet before continuing. If you have any other devices attached to the printer, then turn them off as well, and unplug any cables going into the printer.

 **CAUTION—SHOCK HAZARD:** To avoid the risk of electrical shock, do not use the fax feature during a lightning storm.





 **CAUTION—SHOCK HAZARD:** To avoid the risk of electrical shock when cleaning the exterior of the printer, unplug the power cord from the electrical outlet and disconnect all cables from the printer before proceeding.

 **CAUTION—POTENTIAL INJURY:** If the printer weight is greater than 18 kg (40 lb), then it requires two or more trained personnel to lift it safely.

 **CAUTION—POTENTIAL INJURY:** When moving the printer, follow these guidelines to avoid personal injury or printer damage:

- Make sure that all doors and trays are closed.
- Turn off the printer, and then unplug the power cord from the electrical outlet.
- Disconnect all cords and cables from the printer.
- If the printer has separate floor-standing optional trays or output options attached to it, then disconnect them before moving the printer.
- If the printer has a caster base, then carefully roll it to the new location. Use caution when passing over thresholds and breaks in flooring.
- If the printer does not have a caster base but is configured with optional trays or output options, then remove the output options and lift the printer off the trays. Do not try to lift the printer and any options at the same time.
- Always use the handholds on the printer to lift it.
- Any cart used to move the printer must have a surface able to support the full footprint of the printer.
- Any cart used to move the hardware options must have a surface able to support the dimensions of the options.
- Keep the printer in an upright position.
- Avoid severe jarring movements.
- Make sure that your fingers are not under the printer when you set it down.
- Make sure that there is adequate clearance around the printer.

 **CAUTION—TIPPING HAZARD:** Installing one or more options on your printer or MFP may require a caster base, furniture, or other feature to prevent instability causing possible injury. For more information on supported configurations, contact the place where you purchased the printer.

-  **CAUTION—TIPPING HAZARD:** To reduce the risk of equipment instability, load each tray separately. Keep all other trays closed until needed.
-  **CAUTION—HOT SURFACE:** The inside of the printer might be hot. To reduce the risk of injury from a hot component, allow the surface to cool before touching it.
-  **CAUTION—PINCH HAZARD:** To avoid the risk of a pinch injury, use caution in areas marked with this label. Pinch injuries may occur around moving parts, such as gears, doors, trays, and covers.
-  **CAUTION—POTENTIAL INJURY:** This product uses a laser. Use of controls or adjustments or performance of procedures other than those specified in the *User's Guide* may result in hazardous radiation exposure.
-  **CAUTION—POTENTIAL INJURY:** The lithium battery in this product is not intended to be replaced. There is a danger of explosion if a lithium battery is incorrectly replaced. Do not recharge, disassemble, or incinerate a lithium battery. Discard used lithium batteries according to the manufacturer's instructions and local regulations.

This product is designed, tested, and approved to meet strict global safety standards with the use of specific manufacturer's components. The safety features of some parts may not always be obvious. The manufacturer is not responsible for the use of other replacement parts.

Refer service or repairs, other than those described in the user documentation, to a service representative.

This product uses a printing process that heats the print media, and the heat may cause the media to release emissions. You must understand the section in your operating instructions that discusses the guidelines for selecting print media to avoid the possibility of harmful emissions.

This product may produce small amounts of ozone during normal operation, and may be equipped with a filter designed to limit ozone concentrations to levels well below the recommended exposure limits. To avoid high ozone concentration levels during extensive usage, install this product in a well-ventilated area and replace the ozone and exhaust filters if instructed to do so in the product maintenance instructions. If there are no references to filters in the product maintenance instructions, then there are no filters requiring replacement for this product.

SAVE THESE INSTRUCTIONS.

Learning about the printer

Selecting a location for the printer

- Leave enough room to open trays, covers, and doors and to install hardware options.
- Set up the printer near an electrical outlet.

 **CAUTION—POTENTIAL INJURY:** To avoid the risk of fire or electrical shock, connect the power cord to an appropriately rated and properly grounded electrical outlet that is near the product and easily accessible.

 **CAUTION—SHOCK HAZARD:** To avoid the risk of electrical shock, do not place or use this product near water or wet locations.

- Make sure that airflow in the room meets the latest revision of the ASHRAE 62 standard or the CEN Technical Committee 156 standard.
- Provide a flat, sturdy, and stable surface.
- Keep the printer:
 - Clean, dry, and free of dust
 - Away from stray staples and paper clips
 - Away from the direct airflow of air conditioners, heaters, or ventilators
 - Free from direct sunlight and humidity extremes
- Observe the recommended temperatures and avoid fluctuations.

Ambient temperature	10 to 32°C (50 to 90°F)
Storage temperature	0 to 40°C (32 to 104°F)

- Allow the following recommended amount of space around the printer for proper ventilation:

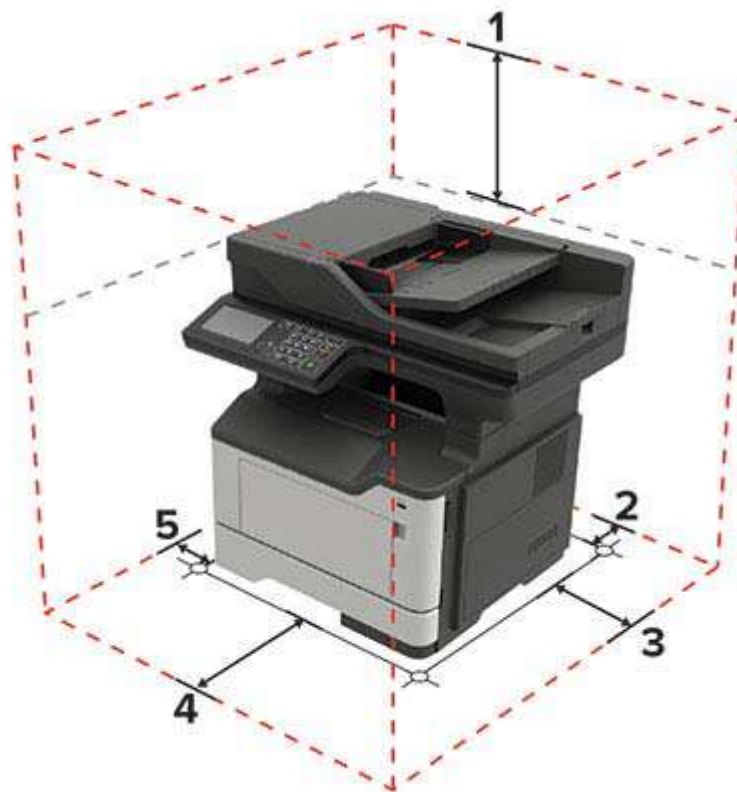

1	Top	737 mm (29 in.)
2	Rear	203 mm (8 in.)
3	Right side	305 mm (12 in.)
4	Front	510 mm (20 in.) Note: The minimum space needed in front of the machine is 76 mm (3 in.).
5	Left side	203 mm (8 in.)

Printer configurations

CAUTION—TIPPING HAZARD: Installing one or more options on your printer or MFP may require a caster base, furniture, or other feature to prevent instability causing possible injury. For more information on supported configurations, contact the place where you purchased the printer.

CAUTION—TIPPING HAZARD: To reduce the risk of equipment instability, load each tray separately. Keep all other trays closed until needed.

You can configure your printer by adding optional 250- or 550-sheet trays. For more information, see [“Installing optional trays” on page 208](#).



1	Control panel
2	Automatic document feeder (ADF)
3	Standard bin
4	Controller board access cover
5	Standard 250-sheet tray
6	Optional 250- or 550-sheet tray
7	Multipurpose feeder
8	Door A

Attaching cables

⚡ CAUTION—SHOCK HAZARD: To avoid the risk of electrical shock, do not set up this product or make any electrical or cabling connections, such as the power cord, fax feature, or telephone, during a lightning storm.

⚠ CAUTION—POTENTIAL INJURY: To avoid the risk of fire or electrical shock, connect the power cord to an appropriately rated and properly grounded electrical outlet that is near the product and easily accessible.

⚠ CAUTION—POTENTIAL INJURY: To avoid the risk of fire or electrical shock, use only the power cord provided with this product or the manufacturer's authorized replacement.

⚠ CAUTION—POTENTIAL INJURY: To reduce the risk of fire, use only a 26 AWG or larger telecommunications (RJ-11) cord when connecting this product to the public switched telephone network. For users in Australia, the cord must be approved by the Australian Communications and Media Authority.

Warning—Potential Damage: To avoid loss of data or printer malfunction, do not touch the USB cable, any wireless network adapter, or the printer in the areas shown while actively printing.



	Use the	To
1	Power cord socket	Connect the printer to an electrical outlet.
2	Ethernet port	Connect the printer to an Ethernet network.
3	LINE port	Connect the printer to an active telephone line through a standard wall jack (RJ-11), DSL filter, or VoIP adapter, or any other adapter that allows you to access the telephone line to send and receive faxes.
4	USB port (678 only)	Attach a keyboard or any compatible option.
5	USB printer port	Connect the printer to a computer.

Using the control panel

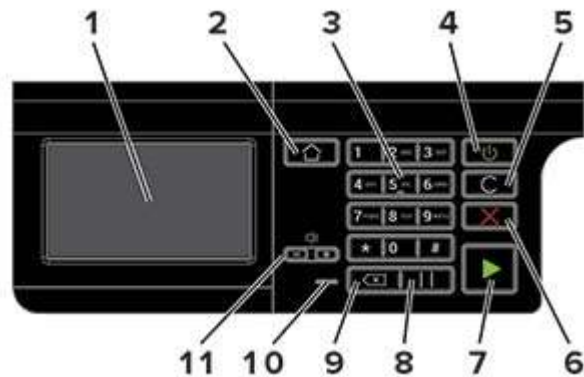

	Use the	To
1	Display	<ul style="list-style-type: none"> View the printer messages and supply status. Set up and operate the printer.
2	Home button	Go to the home screen.
3	Numeric keypad	Enter numbers or symbols in an input field.
4	Power button	Turn on or turn off the printer. Note: To turn off the printer, press and hold the power button for five seconds.
5	Clear all or Reset button	Reset the default settings of a function such as copying, faxing, or scanning.
6	Stop or Cancel button	Stop the current printer task.
7	Start button	Start a printer task, depending on which mode is selected.
8	Pause button	Place a dial pause in a fax number.
9	Backspace button	Move the cursor backward and delete a character in an input field.
10	Indicator light	Check the printer status.
11	Volume buttons	Adjust the speaker volume.

Understanding the status of the power button and indicator light

Indicator light	Printer status
Off	The printer is off or in Hibernate mode.
Blue	The printer is ready or processing data.
Red	The printer requires user intervention.

Power button light	Printer status
Off	The printer is off, ready, or processing data.
Solid amber	The printer is in Sleep mode.

Power button light	Printer status
Blinking amber	The printer is in Hibernate mode.

Using the home screen

Note: Your home screen may vary depending on your home screen customization settings, administrative setup, and active embedded solutions.

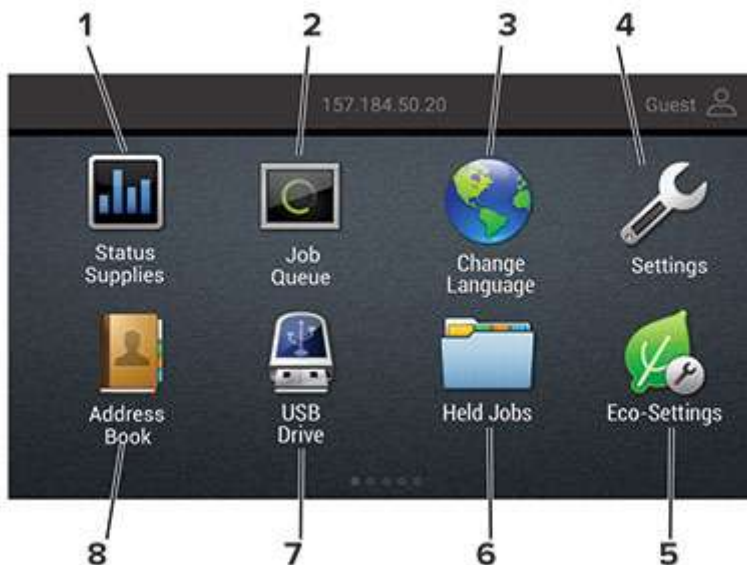

Touch	To
1	Status/Supplies <ul style="list-style-type: none"> Show a warning or error message whenever the printer requires intervention to continue processing. View more information on the printer warning or message, and on how to clear it. <p>Note: You can also access this setting by touching the top section of the home screen.</p>
2	Job Queue <p>Show all the current print jobs.</p> <p>Note: You can also access this setting by touching the top section of the home screen.</p>
3	Change Language <p>Change the language on the display.</p>
4	Settings <p>Access the printer menus.</p>
5	Eco-Settings <p>Manage energy consumption, noise, toner, and paper usage settings.</p>
6	Held Jobs <p>Show the print jobs that are held in the printer memory.</p>
7	USB Drive <p>Print photos and documents from a flash drive.</p>
8	Address Book <p>Manage a contact list that other applications on the printer can access.</p>

Printing the Network Setup Page

From the home screen, touch **Settings > Reports > Network > Network Setup Page**.

Setting up and using the home screen applications

Customizing the home screen

- 1 Open a web browser, and then type the printer IP address in the address field.

Notes:

- View the printer IP address on the printer home screen. The IP address appears as four sets of numbers separated by periods, such as 123.123.123.123.
- If you are using a proxy server, then temporarily disable it to load the web page correctly.

- 2 Click **Settings > Device > Visible Home Screen Icons**.

- 3 Select the icons that you want to appear on the home screen.

- 4 Apply the changes.

Setting up Card Copy

- 1 Open a web browser, and then type the printer IP address in the address field.

Notes:

- View the printer IP address on the printer home screen. The IP address appears as four sets of numbers separated by periods, such as 123.123.123.123.
- If you are using a proxy server, then temporarily disable it to load the web page correctly.

- 2 Click **Apps > Card Copy > Configure**.

- 3 Configure the output options and scan settings.

Notes:

- When scanning a card, make sure that the scan resolution does not exceed 200 dpi for color and 400 dpi for black and white.
- You can scan multiple cards only in printer models that support a printer hard disk.
- When scanning multiple cards, make sure that the scan resolution does not exceed 150 dpi for color and 300 dpi for black and white.
- Make sure that the printer network and e-mail settings are configured.

- 4 Apply the changes.

Using Shortcut Center

- 1 From the home screen, touch **Shortcut Center**, and then select a printer function.

- 2 Touch **Create Shortcut**, and then configure the settings.

- 3 Touch **Save**, and then type a unique shortcut name.
- 4 Apply the changes.

Using Display Customization

Changing the wallpaper

- 1 From the home screen, touch **Change Wallpaper**.
- 2 Select an image to use.
- 3 Apply the changes.

Creating a slide show

Before you begin, make sure to configure the slide show settings. For more information, see the documentation that came with the solution.

- 1 Insert a flash drive into the USB port.
- 2 From the home screen, touch **Slideshow**.

Note: Images appear in alphabetical order.

Setting up Scan Center

- 1 From the home screen, touch **Scan Center**.
- 2 Select and create a destination, and then configure the settings.

Notes:

- When creating a network destination, make sure to validate and adjust the settings until no errors occur.
- Only destinations created from the Embedded Web Server are saved. For more information, see the documentation that came with the solution.

- 3 Apply the changes.

Managing contacts

Adding contacts

- 1 Open a web browser, and then type the printer IP address in the address field.

Notes:

- View the printer IP address on the printer home screen. The IP address appears as four sets of numbers separated by periods, such as 123.123.123.123.
- If you are using a proxy server, then temporarily disable it to load the web page correctly.

- 2 Click **Address Book**.

3 From the Contacts section, add a contact.

Note: You can assign the contact to one or more groups.

4 If necessary, specify a login method to allow application access.

5 Apply the changes.

Adding groups

1 Open a web browser, and then type the printer IP address in the address field.

Notes:

- View the printer IP address on the printer home screen. The IP address appears as four sets of numbers separated by periods, such as 123.123.123.123.
- If you are using a proxy server, then temporarily disable it to load the web page correctly.

2 Click **Address Book**.

3 From the Contact Groups section, add a group name.

Note: You can assign one or more contacts to the group.

4 Apply the changes.

Editing contacts or groups

1 Open a web browser, and then type the printer IP address in the address field.

Notes:

- View the printer IP address on the printer home screen. The IP address appears as four sets of numbers separated by periods, such as 123.123.123.123.
- If you are using a proxy server, then temporarily disable it to load the web page correctly.

2 Click **Address Book**.

3 Do either of the following:

- From the Contacts section, click a contact name, and then edit the information.
- From the Contact Groups section, click a group name, and then edit the information.

4 Apply the changes.

Deleting contacts or groups

1 Open a web browser, and then type the printer IP address in the address field.

Notes:

- View the printer IP address on the printer home screen. The IP address appears as four sets of numbers separated by periods, such as 123.123.123.123.
- If you are using a proxy server, then temporarily disable it to load the web page correctly.

2 Click **Address Book**.

3 Do either of the following:

- From the Contacts section, select a contact that you want to delete.
- From the Contact Groups section, select a group name that you want to delete.

Setting up and using the accessibility features

Enabling Magnification mode

- 1 From the control panel, press and hold the **5** key until you hear a voice message.
- 2 Select **Magnification**.
- 3 Select **OK**.

For more information on navigating a magnified screen, see [“Navigating the screen using gestures” on page 22](#).

Activating Voice Guidance

From the control panel

- 1 Press and hold the **5** key until you hear a voice message.
- 2 Select **OK**.

From the keyboard

- 1 Press and hold the **5** key until you hear a voice message.
- 2 Press **Tab** to navigate the focus cursor to the OK button, and then press **Enter**.

Notes:

- Voice Guidance is also activated when you insert headphones into the headphone jack.
- To adjust the volume, use the volume buttons at the bottom part of the control panel.

Adjusting the Voice Guidance speech rate

- 1 From the home screen, select **Settings > Device > Accessibility > Speech Rate**.
- 2 Select the speech rate.

Enabling spoken passwords or personal identification numbers

- 1 From the home screen, select **Settings > Device > Accessibility > Speak Passwords/PINs**.
- 2 Enable the setting.

Navigating the screen using gestures

Notes:

- The gestures are applicable only when Voice Guidance is activated.
- A physical keyboard is required for typing characters and adjusting certain settings.

Gesture	Function
Double-tap	Select an option or item on the screen.
Triple-tap	Zoom in or zoom out text and images.
Swipe right or swipe down	Move to the next item on the screen.
Swipe left or swipe up	Move to the previous item on the screen.
Pan	Access parts of the zoomed image that are beyond the limits of the screen. Note: This gesture requires the use of two fingers to drag across a zoomed image.
Swipe up then left	Exit an application and return to the home screen.
Swipe down then left	<ul style="list-style-type: none"> • Cancel a job. • Go back to the previous setting. • Exit the screen that appears without changing any setting or value.
Swipe up then down	Repeat a spoken prompt.

Using the keyboard on the display

Do one or more of the following:

- Drag a finger over the key to announce the character.
- Lift the finger to enter or type the character in the field.
- Press **Backspace** to delete characters.
- To hear the content in the input field, press **Tab**, and then press **Shift + Tab**.

Loading paper and specialty media

Setting the size and type of the specialty media

The trays automatically detect the size of plain paper. For specialty media like labels, card stock, or envelopes, do the following:

- 1 From the home screen, navigate to:
Settings > Paper > Tray Configuration > Paper Size/Type > select a paper source
- 2 Set the size and type of the specialty media.

Configuring Universal paper settings

- 1 From the home screen, touch **Settings > Paper > Media Configuration > Universal Setup**.
- 2 Configure the settings.

Loading trays



CAUTION—TIPPING HAZARD: To reduce the risk of equipment instability, load each tray separately. Keep all other trays closed until needed.

- 1 Remove the tray.

Note: To avoid paper jams, do not remove trays while the printer is busy.



- 2** Adjust the paper guides to match the size of the paper that you are loading.

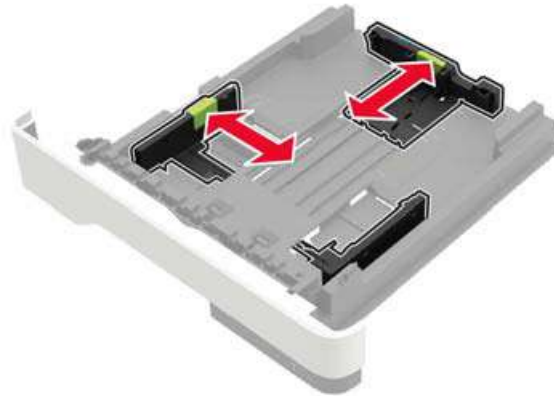

- 3** Flex, fan, and align the paper edges before loading.

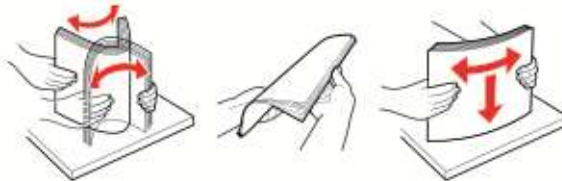

- 4** Load the paper stack with the printable side facedown, and then make sure that the side guides fit snugly against the paper.



Notes:

- Load letterhead facedown with the top edge of the sheet toward the front of the tray for one-sided printing.
- Load letterhead faceup with the bottom edge of the sheet toward the front of the tray for two-sided printing.
- Do not slide paper into the tray.
- To avoid paper jams, make sure that the stack height is below the maximum paper fill indicator.

- 5** Insert the tray.

If necessary, set the paper size and paper type from the control panel to match the paper loaded.

Loading the multipurpose feeder

1 Open the multipurpose feeder.

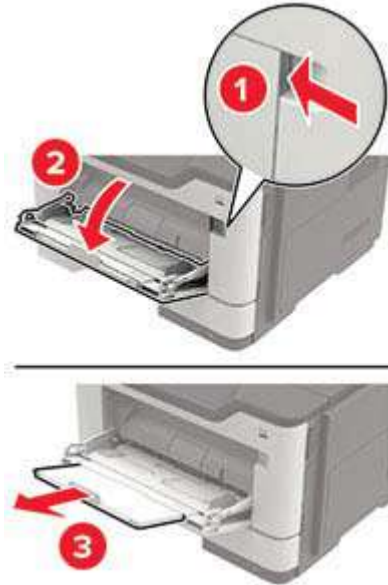

2 Adjust the guide to match the size of the paper that you are loading.



3 Flex, fan, and align the paper edges before loading.

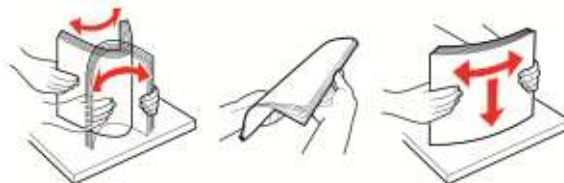

4 Load paper with the printable side faceup.

Notes:

- Load letterhead faceup with the top edge of the sheet toward the front of the tray for one-sided printing.
- Load letterhead facedown with the bottom edge of the sheet toward the front of the tray for two-sided printing.

- Load envelopes with the flap facedown on the left side.
- Load European envelopes with the flap facedown and entering the printer first.

Warning—Potential Damage: Do not use envelopes with stamps, clasps, snaps, windows, coated linings, or self-stick adhesives.

5 From the control panel, set the paper size and paper type to match the paper loaded.

Linking trays

1 Open a web browser, and then type the printer IP address in the address field.

Notes:

- View the printer IP address on the printer home screen. The IP address appears as four sets of numbers separated by periods, such as 123.123.123.123.
- If you are using a proxy server, then temporarily disable it to load the web page correctly.

2 Click **Settings > Paper > Tray Configuration**.

3 Set the same paper size and paper type for the trays that you are linking.

4 Save the settings.

5 Click **Settings > Device > Maintenance > Configuration Menu > Tray Configuration**.

6 Set Tray Linking to **Automatic**.

7 Save the settings.

To unlink trays, make sure that no trays have the same paper size and paper type settings.

Warning—Potential Damage: The temperature of the fuser varies according to the specified paper type. To avoid printing issues, match the paper type setting in the printer with the paper loaded in the tray.

Supported paper

Supported paper sizes

Paper size	Tray	Multipurpose feeder	Two-sided printing	ADF	Scanner glass
A4 210 x 297 mm (8.3 x 11.7 in.)	✓	✓	✓	✓	✓
A5 210 x 148 mm (5.8 x 8.3 in.)	✓	✓	X	✓	✓
A5 LEF* 148 x 210 mm (5.8 x 8.3 in.)	✓	✓	X	✓	✓
A6* 105 x 148 mm (4.1 x 5.8 in.)	✓	✓	X	✓	✓
JIS B5 182 x 257 mm (7.2 x 10.1 in.)	✓	✓	X	✓	✓
Oficio (Mexico) 216 x 340 mm (8.5 x 13.4 in.)	✓	✓	✓	✓	✓
Hagaki 100 x 148 mm (3.9 x 5.8 in.)	X	✓	X	X	✓
Business card 50.8 x 88.9 mm (2 x 3.5 in.)	X	X	X	X	✓
Statement 140 x 216 mm (5.5 x 8.5 in.)	✓	✓	X	✓	✓
Executive 184 x 267 mm (7.3 x 10.5 in.)	✓	✓	X	✓	✓
Letter 216 x 279 mm (8.5 x 11 in.)	✓	✓	✓	✓	✓

* This paper size is not supported in the optional tray.

Paper size	Tray	Multipurpose feeder	Two-sided printing	ADF	Scanner glass
Legal 216 x 356 mm (8.5 x 14 in.)	✓	✓	✓	✓	✓
Folio 216 x 330 mm (8.5 x 13 in.)	✓	✓	✓	✓	✓
Universal 76.2 x 127 mm to 216 x 356 mm (3 x 5 in. to 8.5 x 14 in.)	✓	✓	X	✓	✓
7 3/4 Envelope (Monarch) 98 x 191 mm (3.9 x 7.5 in.)	X	✓	X	X	✓
9 Envelope 98 x 225 mm (3.9 x 8.9 in.)	X	✓	X	X	✓
10 Envelope 105 x 241 mm (4.1 x 9.5 in.)	X	✓	X	X	✓
DL Envelope 110 x 220 mm (4.3 x 8.7 in.)	X	✓	X	X	✓
C5 Envelope 162 x 229 mm (6.4 x 9 in.)	X	✓	X	X	✓
B5 Envelope 176 x 250 mm (6.9 x 9.8 in.)	X	✓	X	X	✓
Other Envelope 76.2 x 127 mm to 216 x 356 mm (3 x 5 in. to 8.5 x 14 in.)	X	✓	X	X	✓

* This paper size is not supported in the optional tray.

Supported paper types

Paper type	Tray	Multipurpose feeder	Two-sided printing	ADF	Scanner glass
Plain paper	✓	✓	✓	✓	✓
Card stock	X	✓	X	X	✓
Transparency	✓	✓	X	X	✓
Recycled	✓	✓	✓	✓	✓
Paper labels ¹	✓	✓	X	X	✓
Bond ²	✓	✓	✓	✓	✓
Letterhead	✓	✓	✓	✓	✓
Preprinted	✓	✓	✓	✓	✓
Colored Paper	✓	✓	✓	✓	✓
Light Paper	✓	✓	✓	✓	✓
Heavy Paper ²	✓	✓	✓	✓	✓
Rough/Cotton	✓	✓	✓	✓	✓
Envelope	X	✓	X	X	✓
Rough envelope	X	✓	X	X	✓

¹ One-sided paper labels designed for laser printers are supported for occasional use. It is recommended to print 20 or fewer pages of paper labels per month. Vinyl, pharmacy, and two-sided labels are not supported.

² Bond and Heavy Paper are supported in two-sided printing up to 90-g/m² (24-lb) paper weight.

Supported paper weights

	Tray	Multipurpose feeder	Two-sided printing	ADF
Paper weight	60–120 g/m ² (16–32 lb)	60–216 g/m ² (16–58 lb)	60–90 g/m ² (16–24 lb)	52–120 g/m ² (14–32 lb)

Printing

Printing from a computer

Note: For labels, card stock, and envelopes, set the paper size and paper type in the printer before printing the document.

- 1 From the document that you are trying to print, open the Print dialog.
- 2 If necessary, adjust the settings.
- 3 Print the document.

Note: For details of the function of the printer driver, refer to the Help of the printer driver.

Printing from a mobile device

Printing from a mobile device using Google Cloud Print

Google Cloud Print™ is a mobile printing service that allows enabled applications on mobile devices to print to any Google Cloud Print-ready printer.

Note: This feature is available only in some printer units.

- 1 From the home screen of your mobile device, launch an enabled application.
- 2 Tap **Print**, and then select a printer.
- 3 Print the document.

Printing from a mobile device using Mopria Print Service

Mopria® Print Service is a mobile printing solution for mobile devices running on Android version 4.4 or later. It allows you to print directly to any Mopria-certified printer.

Note: Before printing, make sure that the Mopria Print Service is enabled.

- 1 From the home screen of your mobile device, launch a compatible application.
- 2 Tap **Print**, and then select a printer.
- 3 Print the document.

Printing from a mobile device using AirPrint

The AirPrint software feature is a mobile printing solution that allows you to print directly from Apple devices to an AirPrint-certified printer.

Notes:

- This application is supported only in some Apple devices.

- This application is supported only in some printer units.

- 1 From the home screen of your mobile device, launch a compatible application.
- 2 Select an item to print, and then tap the share icon.
- 3 Tap **Print**, and then select a printer.
- 4 Print the document.

Printing from a flash drive

- 1 Insert the flash drive.



Notes:

- If you insert the flash drive when an error message appears, then the printer ignores the flash drive.
 - If you insert the flash drive while the printer is processing other print jobs, then **Busy** appears on the display.
- 2 From the display, touch the document that you want to print.
If necessary, configure other print settings.
 - 3 Send the print job.
To print another document, touch **USB Drive**.

Warning—Potential Damage: To avoid loss of data or printer malfunction, do not touch the flash drive or the printer in the area shown while actively printing, reading, or writing from the memory device.



Supported flash drives and file types

Flash drives

Notes:

- The printer supports high-speed USB flash drives with full-speed standard.
- USB flash drives must support the File Allocation Table (FAT) system.

Many flash drives are tested and approved for use with the printer. For more information, contact the place where you purchased the printer.

File types

Documents:

- .doc or .docx
- .xls or .xlsx
- .ppt or .pptx
- .pdf
- .xps

Images:

- .dcx
- .gif
- .jpeg or .jpg
- .bmp
- .pcx
- .tiff or .tif
- .png

Configuring confidential jobs

- 1 From the home screen, touch **Settings** > **Security** > **Confidential Print Setup**.
- 2 Configure the settings.

Use	To
Max Invalid PIN	Limit the number of times an invalid PIN can be entered. Note: When the limit is reached, the print jobs for that user name are deleted.
Confidential Job Expiration	Set the amount of time before confidential jobs are automatically deleted from the printer memory. Note: Confidential held jobs are stored in the printer until you log in and release or delete them manually.
Repeat Job Expiration	Set the amount of time before repeat jobs are deleted from the printer memory. Note: Repeat held jobs are stored so extra copies can be printed later.
Verify Job Expiration	Set the amount of time before verify jobs are deleted from the printer memory. Note: Verify jobs print one copy to check if it is satisfactory before printing the remaining copies.
Reserve Job Expiration	Set the amount of time before reserved jobs are deleted without being printed. Note: Reserve held jobs are automatically deleted after printing.

Printing held jobs

- 1 From the document that you are trying to print, open the Print dialog.
- 2 Select the printer, and then do either of the following:
 - For Windows users, click **Properties** or **Preferences**, and then click **Print and Hold**.
 - For Macintosh users, select **Print and Hold**.
- 3 Select the print job type.
- 4 If necessary, assign a user name.
- 5 Send the print job.
- 6 From the printer home screen, touch **Held Jobs**.
- 7 Send the print job.

Printing a font sample list

- 1 From the home screen, touch **Settings** > **Reports** > **Print** > **Print Fonts**.
- 2 Touch **PCL Fonts** or **PostScript Fonts**.

Canceling a print job

From the printer control panel

- 1 From the home screen, touch **Job Queue**.

Note: You can also access this setting by touching the top section of the home screen.

- 2 Select the job to cancel.

From the computer

- 1 Depending on the operating system, do either of the following:
 - Open the printers folder, and then select your printer.
 - From the System Preferences in the Apple menu, navigate to your printer.
- 2 Select the job to cancel.

Copying

Making copies

- 1 Load an original document into the ADF tray or on the scanner glass.

Note: To avoid a cropped image, make sure that the original document and output have the same paper size.

- 2 From the home screen, touch **Copy**, and then specify the number of copies.

If necessary, adjust the copy settings.

- 3 Copy the document.

Note: To make a quick copy, from the control panel, press .

Copying photos

- 1 Place a photo on the scanner glass.

- 2 From the home screen, touch **Copy** > **Content** > **Photo**.

- 3 From the Content Source menu, select the setting that best matches the original photo.

- 4 Send the copy job.

Copying on letterhead

- 1 Load an original document into the ADF tray or on the scanner glass.

- 2 From the home screen, touch **Copy**, and then specify the size of the original document.

- 3 Touch **Copy to**, and then select the tray that contains the specialty media.

If you are loading the specialty media into the multipurpose feeder, then navigate to:

Multipurpose Feeder > select the size of the specialty media > **Letterhead**

- 4 Send the copy job.

Copying on both sides of the paper (two-sided)

- 1 Load an original document into the ADF tray or on the scanner glass.

- 2 From the home screen, touch **Copy** > **Settings** > **Paper Setup**.

- 3 Adjust the settings.

- 4 Copy the document.

Reducing or enlarging copies

- 1 Load an original document into the ADF tray or on the scanner glass.
- 2 From the home screen, navigate to:
Copy > Scale > specify a scale value
Note: Changing the size of the original document or output after setting Scale restores the scale value to Auto.
- 3 Copy the document.

Collating copies

- 1 Load an original document into the ADF tray or on the scanner glass.
- 2 From the home screen, touch **Copy**, and then set Collate to **On**.
- 3 Copy the document.

Placing separator sheets between copies

- 1 Load an original document into the ADF tray or on the scanner glass.
- 2 From the home screen, touch **Copy > Separator Sheets**.
- 3 Adjust the settings.
- 4 Send the copy job.

Copying multiple pages onto a single sheet

- 1 Load an original document into the ADF tray or on the scanner glass.
- 2 From the home screen, touch **Copy > Pages per Side**.
- 3 Adjust the settings.
- 4 Copy the document.

Creating a copy shortcut

- 1 From the home screen, touch **Copy**.
- 2 Adjust the settings, and then touch .
- 3 Enter a shortcut name.
- 4 Apply the changes.

E-mailing

Setting up the e-mail function

- 1 From the home screen, touch **Settings** > **Device** > **Preferences** > **Run Initial Setup**.
- 2 Turn off the printer, wait for about 10 seconds, and then turn it back on.
- 3 From the Before You Begin screen, select **Change the Settings and Continue with the Wizard**.
- 4 From the Fax/Email Server Setup screen, enter the needed information.
- 5 Finish the setup.

Configuring e-mail settings

- 1 Open a Web browser, and then type the printer IP address in the address field.

Notes:

- View the printer IP address on the printer home screen. The IP address appears as four sets of numbers separated by periods, such as 123.123.123.123.
- If you are using a proxy server, then temporarily disable it to load the Web page correctly.

- 2 Click **Settings** > **E-mail**.
- 3 Enter the needed information.
- 4 Apply the changes.

Sending an e-mail

Using the control panel

- 1 Load an original document into the ADF tray or on the scanner glass.
- 2 From the home screen, touch **E-mail**, and then enter the needed information.

Note: You can also enter the recipient using the address book or shortcut number.
- 3 If necessary, configure the output file type settings.
- 4 Send the e-mail.

Using the shortcut number

- 1 From the control panel, press **#**, and then enter the shortcut number using the keypad.
- 2 Send the e-mail.

Creating an e-mail shortcut

- 1 From the home screen, touch **E-mail**.
- 2 Configure the settings, and then touch .
- 3 Enter a shortcut name.
- 4 Apply the changes.

Faxing

Setting up the printer to fax

Notes:

- The following connection methods are applicable only in some countries or regions.
- During the initial printer setup, clear the fax function check box and any other function you plan to set up later, and then select **Continue**.
- If the fax function is enabled and not fully set up, then the indicator light may blink red.

Warning—Potential Damage: To avoid loss of data or printer malfunction, do not touch cables or the printer in the area shown while actively sending or receiving a fax.



Setting up the fax function

- 1 From the home screen, touch **Settings > Device > Preferences > Run Initial Setup**.
- 2 Turn off the printer, wait for about 10 seconds, and then turn it back on.
- 3 From the Before You Begin screen, select **Change the Settings and Continue with the Wizard**.
- 4 From the Fax/Email Server Setup screen, enter the needed information.
- 5 Finish the setup.

Setting up fax using a standard telephone line

- ⚠ **CAUTION—SHOCK HAZARD:** To avoid the risk of electrical shock, do not set up this product or make any electrical or cabling connections, such as the power cord, fax feature, or telephone, during a lightning storm.
- ⚠ **CAUTION—SHOCK HAZARD:** To avoid the risk of electrical shock, do not use the fax feature during a lightning storm.

⚠ CAUTION—POTENTIAL INJURY: To reduce the risk of fire, use only a 26 AWG or larger telecommunications (RJ-11) cord when connecting this product to the public switched telephone network. For users in Australia, the cord must be approved by the Australian Communications and Media Authority.

Setup 1: Printer is connected to a dedicated fax line

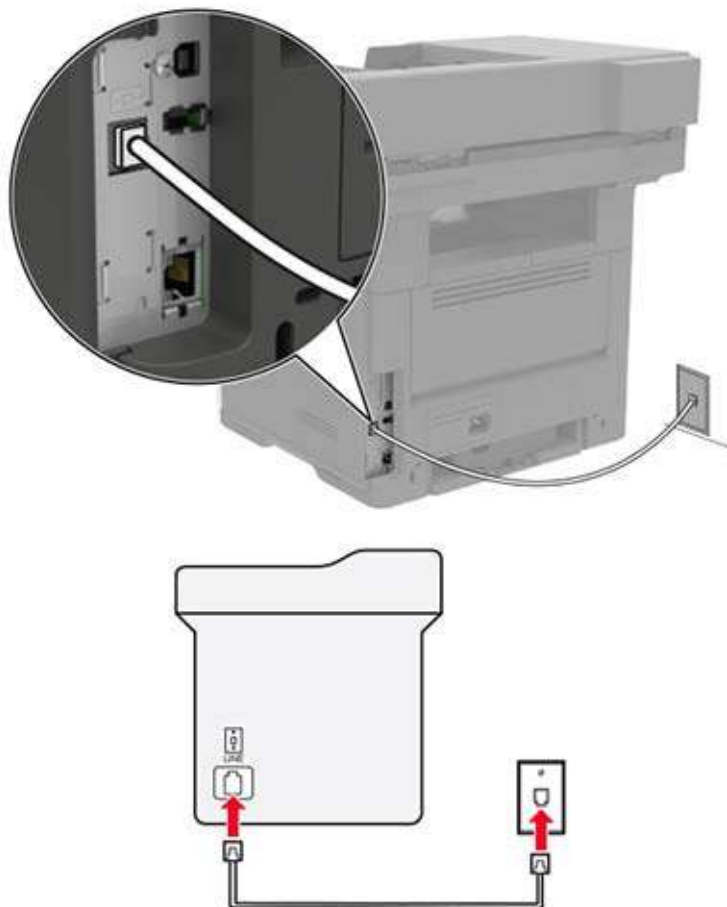

- 1 Connect one end of the telephone cable to the line port of the printer.
- 2 Connect the other end of the cable to an active analog wall jack.

Notes:

- You can set the printer to receive faxes automatically (Auto Answer On) or manually (Auto Answer Off).
- If you want to receive faxes automatically, then set the printer to pick up on a specified number of rings.

Setup 2: Printer is sharing the line with an answering machine

Note: If you subscribe to a distinctive ring service, then make sure that you set the correct ring pattern for the printer. Otherwise, the printer does not receive faxes even if you have set it to receive faxes automatically.

Connected to different wall jacks

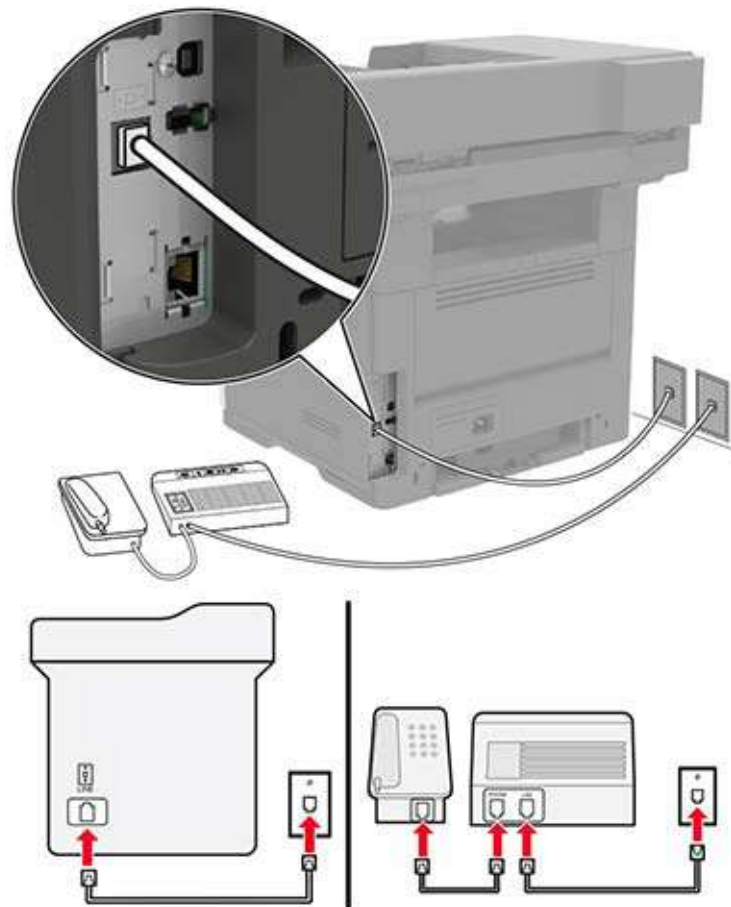

- 1 Connect one end of the telephone cable to the line port of the printer.
- 2 Connect the other end of the cable to an active analog wall jack.

Notes:

- If you have only one telephone number on your line, then set the printer to receive faxes automatically.
- Set the printer to pick up calls two rings after the answering machine. For example, if the answering machine picks up calls after four rings, then set the printer Rings to Answer setting to six.

Setting up fax in countries or regions with different telephone wall jacks and plugs

⚠ CAUTION—SHOCK HAZARD: To avoid the risk of electrical shock, do not set up this product or make any electrical or cabling connections, such as the power cord, fax feature, or telephone, during a lightning storm.

⚠ CAUTION—SHOCK HAZARD: To avoid the risk of electrical shock, do not use the fax feature during a lightning storm.

⚠ CAUTION—POTENTIAL INJURY: To reduce the risk of fire, use only a 26 AWG or larger telecommunications (RJ-11) cord when connecting this product to the public switched telephone network. For users in Australia, the cord must be approved by the Australian Communications and Media Authority.

The standard wall jack adopted by most countries or regions is RJ11. If the wall jack or equipment in your facility is not compatible with this type of connection, then use a telephone adapter. An adapter for your country or region may not come with your printer, and you may need to purchase it separately.

There may be an adapter plug installed in the telephone port of the printer. Do not remove the adapter plug from the telephone port of the printer if you are connecting to a serial or cascaded telephone system.

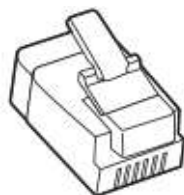

Connecting the printer to a non-RJ11 wall jack

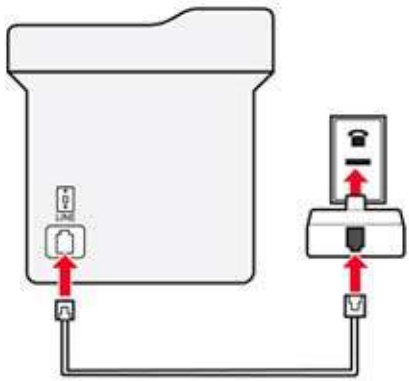
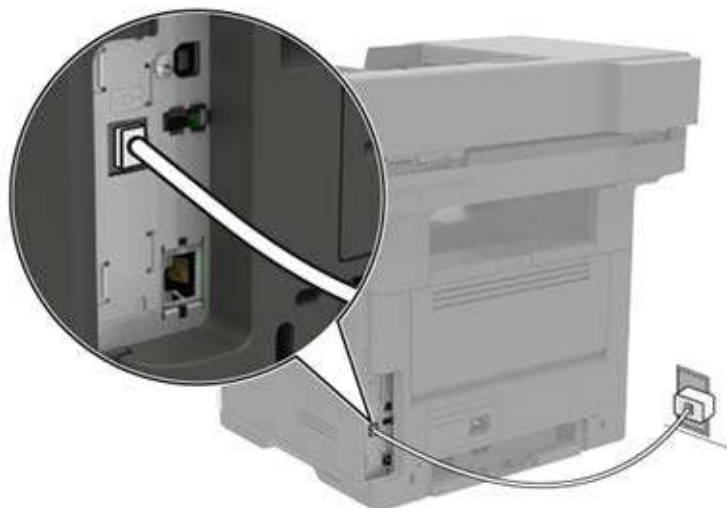

- 1 Connect one end of the telephone cable to the line port of the printer.
- 2 Connect the other end of the cable to the RJ11 adapter, and then connect the adapter to the wall jack.
- 3 If you want to connect another device with a non-RJ11 connector to the same wall jack, then connect it directly to the telephone adapter.

Connecting the printer to a wall jack in Germany

The German wall jack has two kinds of ports. The N ports are for fax machines, modems, and answering machines. The F port is for telephones. Connect the printer to any of the N ports.

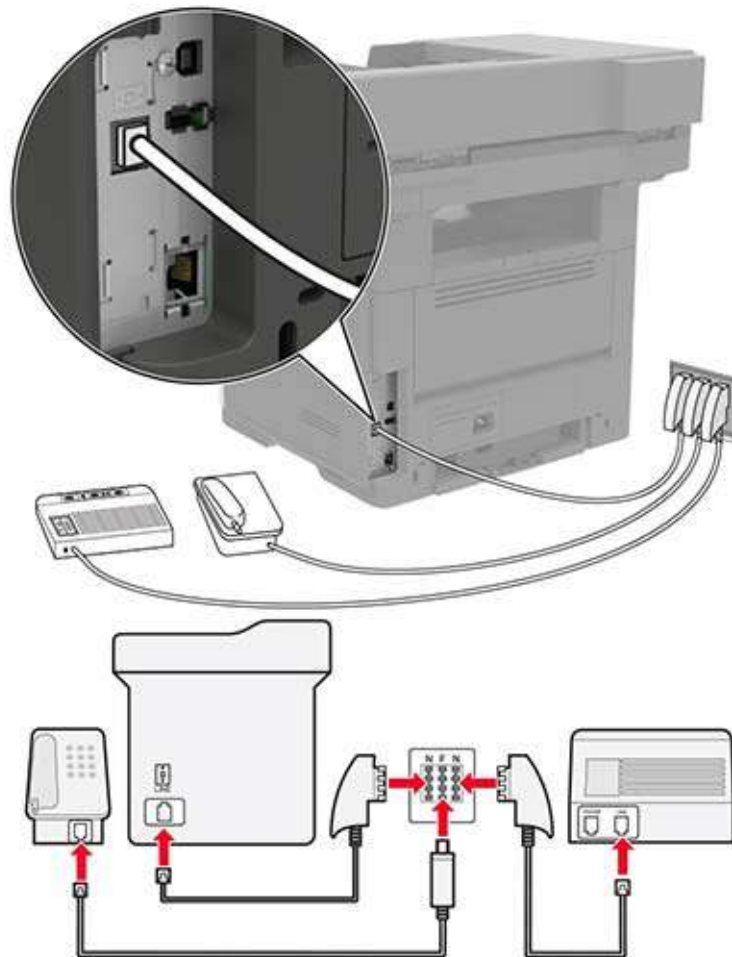

- 1 Connect one end of the telephone cable to the line port of the printer.
- 2 Connect the other end of the cable to the RJ11 adapter, and then connect the adapter to an N port.
- 3 If you want to connect a telephone and answering machine to the same wall jack, then connect the devices as shown.

Connecting to a distinctive ring service

A distinctive ring service lets you have multiple telephone numbers on one telephone line. Each telephone number is assigned a different ring pattern.

- 1 From the home screen, touch **Settings > Fax > Analog Fax Setup > Fax Receive Settings > Admin Controls > Answer On**.
- 2 Select the ring pattern.
- 3 Apply the changes.

Setting the fax date and time

- 1 From the home screen, touch **Settings > Device > Preferences > Date and Time > Configure**.
- 2 Configure the settings.

Configuring daylight saving time

- 1 From the home screen, touch **Settings > Device > Preferences > Date and Time > Configure**.
- 2 In the Time Zone menu, select **Custom**.
- 3 Configure the settings.

Sending a fax

Using the control panel

- 1 Load the original document into the ADF tray or on the scanner glass.
- 2 From the home screen, touch **Fax**, and then enter the needed information.
- 3 If necessary, configure other fax settings.
- 4 Send the fax job.

Using the computer

For Windows users

- 1 With a document open, click **File > Print**.
- 2 Select the printer, and then click **Properties, Preferences, Options, or Setup**.
- 3 Click **Fax > Enable fax**, and then enter the recipient number.
- 4 If necessary, configure other fax settings.
- 5 Send the fax job.

For Macintosh users

- 1 With a document open, choose **File > Print**.
- 2 Select the printer and enter the recipient number.
- 3 If necessary, configure other fax settings.
- 4 Send the fax job.

Scheduling a fax

- 1 Load the original document into the ADF tray or on the scanner glass.
- 2 From the home screen, navigate to:
Fax > enter the fax number > Send Time
- 3 Configure the date and time to send the fax.
- 4 If necessary, configure other fax settings.
- 5 Send the fax job.

Creating a fax destination shortcut

- 1 From the home screen, touch **Fax > To**.
- 2 Enter the recipient number.

Note: To create a group of fax numbers, touch , and then enter another fax number.

- 3 Touch .
- 4 Enter a shortcut name.
- 5 Apply the changes.

Changing the fax resolution

- 1 Load an original document into the ADF tray or on the scanner glass.
- 2 From the home screen, touch **Fax**, and then enter the needed information.
- 3 Adjust the Resolution setting.
- 4 Send the fax job.

Adjusting the fax darkness

- 1 Load an original document into the ADF tray or on the scanner glass.
- 2 From the home screen, touch **Fax**, and then enter the needed information.

- 3 Adjust the Darkness setting.
- 4 Send the fax job.

Viewing a fax log

- 1 Open a Web browser, and then type the printer IP address in the address field.

Notes:

- View the printer IP address on the printer home screen. The IP address appears as four sets of numbers separated by periods, such as 123.123.123.123.
- If you are using a proxy server, then temporarily disable it to load the Web page correctly.

- 2 Click **Settings > Reports > Fax**.
- 3 Click **Fax Job Log** or **Fax Call Log**.

Blocking junk faxes

- 1 From the home screen, touch **Settings > Fax > Analog Fax Setup > Fax Receive Settings > Admin Controls > Block No Name Fax**.
- 2 Apply the changes.

Holding faxes

- 1 From the home screen, touch **Settings > Fax > Analog Fax Setup > Fax Receive Settings > Holding Faxes**.
- 2 Select a mode.

Forwarding a fax

- 1 From the home screen, touch **Settings > Fax > Analog Fax Setup > Fax Receive Settings > Admin Controls**.
- 2 Configure the Fax Forwarding, Forward To, and Forward to Shortcut settings.
- 3 Apply the changes.

Scanning

Scanning to an FTP server

- 1 Load the original document into the ADF tray or on the scanner glass.
- 2 From the home screen, touch **FTP**, and then enter the needed information.
- 3 If necessary, configure other FTP settings.
- 4 Send the FTP job.

Creating an FTP shortcut

- 1 From the home screen, touch **FTP**.
- 2 Enter the FTP server address, and then touch .
- 3 Enter a shortcut name.
- 4 Apply the changes.

Scanning to a flash drive

- 1 Load an original document into the ADF tray or on the scanner glass.
- 2 Insert the flash drive.



- 3 Touch **Scan to USB** and adjust the settings if necessary.

Note: If the USB Drive screen does not appear, then touch **USB Drive** on the home screen.

4 Scan the document.

Warning—Potential Damage: To avoid loss of data or printer malfunction, do not touch the flash drive or the printer in the area shown while actively printing, reading, or writing from the memory device.



Sending scanned documents to a computer

- 1 Load an original document into the ADF tray or on the scanner glass.
- 2 From the home screen, touch **Scan Profiles > Scan To Computer**.
- 3 Select the scan profile where you want to save the document.

Understanding the printer menus

Menu map

Device	<ul style="list-style-type: none"> • Preferences • Remote Operator Panel • Notifications • Power Management • Accessibility 	<ul style="list-style-type: none"> • Restore Factory Defaults • Maintenance • Visible Home Screen Icons • About This Printer
Print	<ul style="list-style-type: none"> • Layout • Setup • Quality • Job Accounting • XPS 	<ul style="list-style-type: none"> • PDF • PostScript • PCL • HTML • Image
Paper	<ul style="list-style-type: none"> • Tray Configuration 	<ul style="list-style-type: none"> • Media Configuration
Copy	Copy Defaults	
Fax	<ul style="list-style-type: none"> • Fax Mode • Analog Fax Setup 	<ul style="list-style-type: none"> • Fax Server Setup
E-mail	<ul style="list-style-type: none"> • E-mail Setup • E-mail Defaults 	<ul style="list-style-type: none"> • Web Link Setup
FTP	FTP Defaults	
USB Drive	<ul style="list-style-type: none"> • Flash Drive Scan 	<ul style="list-style-type: none"> • Flash Drive Print
Network/Ports	<ul style="list-style-type: none"> • Network Overview • Wireless • AirPrint • Ethernet • TCP/IP • SNMP 	<ul style="list-style-type: none"> • IPSec • LPD Configuration • HTTP/FTP Settings • ThinPrint • USB • Google Cloud Print
Security	<ul style="list-style-type: none"> • Login Methods • Schedule USB Devices • Security Audit Log • Login Restrictions • Confidential Print Setup 	<ul style="list-style-type: none"> • Disk Encryption • Erase Temporary Data Files • Solutions LDAP Settings • Mobile Services Management • Miscellaneous
Reports	<ul style="list-style-type: none"> • Menu Settings Page • Device • Print 	<ul style="list-style-type: none"> • Shortcuts • Fax • Network

Help	<ul style="list-style-type: none"> • Print All Guides • Connection Guide • Copy Guide • E-mail Guide • Fax Guide • FTP Guide • Information Guide 	<ul style="list-style-type: none"> • Media Guide • Mono Quality Guide • Moving Guide • Print Quality Guide • Scan Guide • Supplies Guide
Troubleshooting	<ul style="list-style-type: none"> • Print Quality Test Pages 	

Device

Preferences

Menu item	Description
Display Language [List of languages]	Set the language of the text that appears on the display.
Country/Region [List of countries or regions]	Identify the country or region where the printer is configured to operate.
Run initial setup On Off*	Run the setup wizard.
Keyboard Keyboard Type [List of languages]	Select a language as a keyboard type. Notes: <ul style="list-style-type: none"> • All the Keyboard Type values may not appear or may require special hardware to appear. • This menu item appears only in some printer models.
Displayed information Display Text 1 [IP Address*] Display Text 2 [Date/Time*] Custom Text 1 Custom Text 2	Specify the information to appear on the home screen. Note: Custom Text 1 and Custom Text 2 appear only in some printer models.
Date and Time Configure Current Date and Time Manually Set Date and Time Date Format [MM-DD-YYYY*] Time Format [12 hour A.M./P.M.*] Time Zone [GMT*]	Configure the printer date and time.
Note: An asterisk (*) next to a value indicates the factory default setting.	

Menu item	Description
Date and Time Network Time Protocol Enable NTP [On*] NTP Server Enable Authentication	Configure the settings for Network Time Protocol (NTP). Notes: <ul style="list-style-type: none"> • Enable Authentication appears only in some printer models. • When Enable Authentication is set to MD5 key, Key ID and Password appear.
Paper Sizes U.S.* Metric	Specify the unit of measurement for paper sizes. Note: The country or region selected in the initial setup wizard determines the initial paper size setting.
Screen Brightness 20–100% (100*)	Adjust the brightness of the display. Note: This menu item appears only in some printer models.
Flash Drive Access Enabled* Disabled	Enable access to the flash drive.
Allow Background Removal On* Off	Specify whether background removal is allowed.
Allow Custom Job scans On* Off	Scan multiple jobs to one file.
One Page Flatbed Scanning On Off*	Set copies from the scanner glass to only one page at a time.
Audio Feedback Button Feedback On* Off	Enable audio feedback for button presses, panel interactions, paper loaded prompts, and error notifications. Note: This menu item appears only in some printer models.
Audio Feedback Volume 1–10 (5*)	Adjust the volume of the printer speakers. Notes: <ul style="list-style-type: none"> • Changes to the volume are applied after the current user session ends. • This menu item appears only in some printer models.
Screen Timeout 10–300 (60*)	Set the idle time in seconds before the display shows the home screen, or before the printer logs off a user account automatically.
Note: An asterisk (*) next to a value indicates the factory default setting.	

Remote Operator Panel

Menu item	Description
External VNC Connection Don't Allow* Allow	Connect an external Virtual Network Computing (VNC) client to the remote control panel.
Authentication Type None* Standard Authentication	Set the authentication type when accessing the VNC client server. Note: When set to Standard Authentication, VNC Password appears.
Note: An asterisk (*) next to a value indicates the factory default setting.	

Notifications

Menu item	Description
Error Lighting Off On*	Set the indicator light to come on when a printer error occurs. Note: This menu item appears only in some printer models.
ADF Loaded Beep Off On*	Enable a sound when loading paper into the ADF.
Alarm Control Off Single* Continuous	Set the number of times that the alarm sounds when the printer requires user intervention.
Supplies Show Supply Estimates Show estimates* Do not show estimates	Show the estimated status of the supplies.
Supplies Cartridge Alarm Off* Single Continuous	Set the number of times that the alarm sounds when the toner cartridge is low.
E-mail Alerts Setup	Configure the printer to send e-mail alerts to a list of contacts when the printer requires user intervention.
Error Prevention Jam Assist Off On*	Set the printer to flush automatically blank pages or pages with partial prints after a jammed page is cleared.
Note: An asterisk (*) next to a value indicates the factory default setting.	

Menu item	Description
<p>Error Prevention Auto Continue Disabled 5–255 (5*)</p>	<p>Let the printer to continue processing or printing a job automatically after clearing certain attendance conditions.</p>
<p>Error Prevention Auto Reboot Auto Reboot Reboot when idle Reboot always* Reboot never</p>	<p>Set the printer to restart when an error occurs.</p>
<p>Error Prevention Auto Reboot Max Auto Reboots 1–20 (2*)</p>	<p>Set the number of automatic reboots that the printer can perform.</p>
<p>Error Prevention Auto Reboot Auto Reboot Window 1–525600 (720*)</p>	<p>Set the number of seconds before the printer performs an automatic reboot.</p>
<p>Error Prevention Auto Reboot Auto Reboot Counter</p>	<p>Show a read-only information of the reboot counter.</p>
<p>Error Prevention Auto Reboot Reset Auto Reboot Counter Cancel Continue</p>	<p>Reset Auto Reboot Counter.</p>
<p>Error Prevention Display Short Paper Error On Auto-clear*</p>	<p>Set the printer to show a message when a short paper error occurs. Note: Short paper refers to the size of the paper loaded.</p>
<p>Error Prevention Page Protect Off* On</p>	<p>Set the printer to process the entire page into the memory before printing it.</p>
<p>Jam Content Recovery Jam Recovery Off On Auto*</p>	<p>Set the printer to reprint jammed pages.</p>
<p>Note: An asterisk (*) next to a value indicates the factory default setting.</p>	

Menu item	Description
Jam Content Recovery Scanner Jam Recovery Job level Page level*	Specify how to restart a scan job after resolving a paper jam.
Note: An asterisk (*) next to a value indicates the factory default setting.	

Power Management

Menu item	Description
Sleep Mode Profile Print with Display off Allow printing with display off* Display on when printing	Allow printing with the display turned off.
Timeouts Sleep Mode 1–120 minutes (15*)	Set the idle time before the printer begins operating in Sleep mode.
Timeouts Hibernate Timeout Disabled 1 hour 2 hours 3 hours 6 hours 1 day 2 days 3 days* 1 week 2 weeks 1 month	Set the time before the printer enters Hibernate mode.
Timeouts Hibernate Timeout on Connection Hibernate Do Not Hibernate*	Set the printer to Hibernate mode even when an active Ethernet connection exists.
Eco-Mode Off* Energy Energy/Paper Paper	Minimize the use of energy, paper, or specialty media. Note: Setting Eco-Mode to Energy or Paper may affect printer performance, but not print quality.
Note: An asterisk (*) next to a value indicates the factory default setting.	

Accessibility

Note: This menu appears only in some printer models.

Menu item	Description
Duplicate Key Strike Interval 0–5 (0*)	Set the interval in seconds during which the printer ignores duplicate key presses on an attached keyboard.
Key Repeat Initial Delay 0.25–5 (1*)	Set the initial length of delay in seconds before a repeating key starts repeating. Note: This menu item appears only when a keyboard is attached to the printer.
Key Repeat Rate 0.5–30 (30*)	Set the number of presses per second for a repeating key. Note: This menu item appears only when a keyboard is attached to the printer.
Prolong Screen Timeout Off* On	Let the user remain in the same location and reset the Screen Timeout timer when it expires instead of returning to the home screen.
Headphone Volume 1–10 (5*)	Adjust the headphone volume. Note: This menu item appears only when a headphone is attached to the printer.
Enable Voice Guidance When Headphone Is Attached Off* On	Enable Voice Guidance when a headphone is attached to the printer.
Speak Passwords/PINs Off* On	Set the printer to read out loud passwords or personal identification numbers. Note: This menu item appears only when a headphone or a speaker is attached to the printer.
Speech Rate Very Slow Slow Normal* Fast Faster Very Fast Rapid Very Rapid Fastest	Set the Voice Guidance speech rate. Note: This menu item appears only when a headphone or a speaker is attached to the printer.
Note: An asterisk (*) next to a value indicates the factory default setting.	

Restore Factory Defaults

Menu item	Description
Restore Settings Restore all settings Restore printer settings Restore network settings Restore fax settings Restore app settings	Restore the printer factory default settings. Note: The default value is the value selected during the initial setup.

Maintenance

Configuration Menu

Menu item	Description
USB Configuration USB PnP 1* 2	Change the USB driver mode of the printer to improve its compatibility with a personal computer. Note: This menu item appears only in some printer models.
USB Scan to Local On* Off	Set whether the USB device driver enumerates as a USB Simple device (single interface) or as a USB Composite device (multiple interfaces).
USB Configuration USB Speed Full Auto*	Set the USB port to run at full speed and disable its high-speed capabilities. Note: This menu item appears only in some printer models.
Tray Configuration Tray Linking Automatic* Off	Set the printer to link the trays that have the same paper type and paper size settings.
Tray Configuration Show Tray Insert Message Off* On	Show the Tray Insert message.
Tray Configuration A5 Loading Short Edge* Long Edge	Specify the page orientation when loading A5-size paper.

Note: An asterisk (*) next to a value indicates the factory default setting.

Menu item	Description
<p>Tray Configuration</p> <ul style="list-style-type: none"> Paper Prompts <ul style="list-style-type: none"> Auto* Multipurpose Feeder Manual Paper Envelope Prompts <ul style="list-style-type: none"> Auto* Multipurpose Feeder Manual Envelope 	<p>Set the paper source that the user fills when a prompt to load paper or envelope appears.</p> <p>Notes:</p> <ul style="list-style-type: none"> • The multipurpose feeder is available only in some printer models. • For Multipurpose Feeder to appear, set Configure MP to Cassette from the Paper menu.
<p>Tray Configuration</p> <ul style="list-style-type: none"> Action for Prompts <ul style="list-style-type: none"> Prompt user* Continue Use current 	<p>Set the printer to resolve paper- or envelope-related change prompts.</p>
<p>Reports</p> <ul style="list-style-type: none"> Menu Settings Page Event Log Event Log Summary HealthCheck Statistics 	<p>Print reports about printer menu settings, status, and event logs.</p>
<p>Supply Usage And Counters</p> <ul style="list-style-type: none"> Clear Supply Usage History 	<p>Reset the supply usage history, such as number of pages and days remaining, to the factory shipped level.</p>
<p>Supply Usage And Counters</p> <ul style="list-style-type: none"> Reset Maintenance Counter 	<p>Reset the counter after installing a new maintenance kit.</p>
<p>Printer Emulations</p> <ul style="list-style-type: none"> PPDS Emulation <ul style="list-style-type: none"> Off* On 	<p>Set the printer to recognize and use the PPDS data stream.</p>
<p>Fax Configuration</p> <ul style="list-style-type: none"> Fax Low Power Support <ul style="list-style-type: none"> Disable Sleep Permit Sleep Auto* 	<p>Set fax to enter Sleep mode whenever the printer determines that it should.</p>
<p>Fax Configuration</p> <ul style="list-style-type: none"> Fax Storage Location <ul style="list-style-type: none"> Disk NAND* 	<p>Set the storage location for all faxes.</p>
<p>Print Configuration</p> <ul style="list-style-type: none"> Font Sharpening <ul style="list-style-type: none"> 0–150 (24*) 	<p>Set a text point-size value below which the high-frequency screens are used when printing font data.</p> <p>For example, if the value is 24, then all fonts sized 24 points or less use the high-frequency screens.</p>
<p>Note: An asterisk (*) next to a value indicates the factory default setting.</p>	

Menu item	Description
Print Configuration Print Density 1–5 (3*) Copy Density 1–5 (3*)	Adjust the toner density when printing or copying documents.
Device Operations Quiet Mode Off* On	Set the printer to operate in Quiet Mode. Note: Enabling this setting slows down the printer performance.
Device Operations Panel Menus Off On*	Enable access to the control panel menus.
Device Operations Custom Supply Levels Off* On	Let <i>printservice</i> read and edit values from the Embedded Web Server.
Device Operations Safe Mode Off* On	Set the printer to operate in a special mode, in which it attempts to continue offering as much functionality as possible, despite known issues. For example, when set to On, and the duplex motor is nonfunctional, the printer performs one-sided printing of the documents even if the job is two-sided printing.
Device Operations Minimum Copy Memory 80 MB* 100 MB	Set the minimum memory allocation for storing copy jobs.
Device Operations Clear Custom Status	Erase user-defined strings for the Default or Alternate custom messages.
Device Operations Clear all remotely-installed messages	Erase messages that were remotely installed.
Device Operations Automatically Display Error Screens Off On*	Show existing error messages on the display after the printer remains inactive on the home screen for a length of time equal to the Screen Timeout setting.
Device Operations Honor orientation on fast path copy On Off*	Enable the printer to use the orientation setting under the Copy menu when sending quick copy jobs.
Note: An asterisk (*) next to a value indicates the factory default setting.	

Menu item	Description
Device Operations Enable Optional Parallel Port Off* On	Enable an optional parallel port. Note: When set to On, the printer restarts.
Scanner Configuration Scanner Manual Registration Print Quick Test	Print a Quick Test target page. Note: Make sure that the margin spacing on the target page is uniform all the way around the target. If it is not, then the printer margins may need to be reset.
Scanner Configuration Scanner Manual Registration Front ADF Registration Rear ADF Registration Flatbed Registration	Manually register the flatbed and ADF after replacing the ADF, scanner glass, or controller board.
Scanner Configuration Edge Erase Flatbed Edge Erase 0–6 (3*) ADF Edge Erase 0–6 (3*)	Set the size, in millimeters, of the no-print area around an ADF or flatbed scan job.
Scanner Configuration ADF Deskew ADF Mechanical Deskew Off On Auto*	Set the printer to perform ADF mechanical skew adjustment.
Scanner Configuration Disabled Scanner Enabled* Disabled ADF Disabled	Disable the scanner when it is not working properly.
Scanner Configuration Tiff Byte Order CPU Endianness* Little Endian Big Endian	Set the byte order of a TIFF-formatted scan output.
Scanner Configuration Exact Tiff Rows Per Strip On* Off	Set the RowsPerStrip tag value of a TIFF-formatted scan output.
Note: An asterisk (*) next to a value indicates the factory default setting.	

Out of Service Erase

Menu item	Description
Out of Service Erase Memory Last Sanitized Hard Disk Last Sanitized	Show information on when the printer memory or hard disk was last sanitized. Note: Hard Disk Last Sanitized appears only in printers with a hard disk installed.
Out of Service Erase Sanitize all information on nonvolatile memory Sanitize all information on hard disk Erase all printer and network settings	Clear all settings and applications that are stored in the printer memory or hard disk. Note: Sanitize all information on hard disk appears only in printers with a hard disk installed.

Visible Home Screen Icons

Note: This menu appears only in some printer models.

Menu	Description
Visible Home Screen Icons Copy E-mail Fax Status/Supplies Job Queue Change Language Shortcut Center Address Book Bookmarks Held Jobs USB FTP Scan Profiles App Profiles Display Customization Scan Center Card Copy	Specify which icons to show on the home screen.

About this Printer

Menu item	Description
Asset Tag¹	Describe the printer. The maximum length is 32 characters.
Printer's Location¹	Identify the printer location. The maximum length is 63 characters.

¹ In some printer models, this menu item can be configured only from the Embedded Web Server.

² This menu item appears only in some printer models.

Menu item	Description
Contact¹	Personalize the printer name. The maximum length is 63 characters.
Export Configuration File to USB²	Export configuration files to a flash drive.
Export Compressed Logs to USB²	Export compressed log files to a flash drive.
¹ In some printer models, this menu item can be configured only from the Embedded Web Server. ² This menu item appears only in some printer models.	

Print

Layout

Menu item	Description
Sides (Duplex) Off* On	Print on both sides of the paper.
Duplex Binding Long Edge* Short Edge	Define binding for two-sided pages, and how the printing on the back of the sheet is oriented in relation to the printing on the front. Notes: <ul style="list-style-type: none"> • Long Edge assumes binding along the long edge of the page (left edge for portrait and top edge for landscape). • Short Edge assumes binding along the short edge of the page (top edge for portrait and left edge for landscape).
Blank Pages Do Not Print* Print	Print blank pages that are included in a print job.
Collate Off [1,1,1,2,2,2] On [1,2,1,2,1,2]*	Print multiple copies in sequence.
Separator Sheets None* Between Copies Between Jobs Between Pages	Specify whether to insert blank separator sheets when printing.
Separator Sheet Source Tray [x] (1*) Multipurpose Feeder	Specify the paper source for the separator sheet. Note: For Multipurpose Feeder to appear, set Configure MP to Cassette from the Paper menu.
Note: An asterisk (*) next to a value indicates the factory default setting.	

Menu item	Description
Pages per Side Off* 2 pages per side 3 pages per side 4 pages per side 6 pages per side 9 pages per side 12 pages per side 16 pages per side	Print multiple page images on one side of a sheet of paper.
Pages per Side Ordering Horizontal* Reverse Horizontal Reverse Vertical Vertical	Specify the positioning of multiple page images when using Pages per Side. Note: The positioning depends on the number of page images and their page orientation.
Pages per Side Orientation Auto* Landscape Portrait	Specify the orientation of a multiple-page document when using Pages per Side.
Pages per Side Border None* Solid	Print a border around each page image when using Pages per Side.
Copies 1–999 (1*)	Specify the number of copies for each page in a print job.
Print Area Normal* Whole Page	Set the printable area on a sheet of paper.
Note: An asterisk (*) next to a value indicates the factory default setting.	

Setup

Menu item	Description
Printer Language PCL Emulation PS Emulation*	Set the printer language. Note: Setting a printer language default does not prevent a software program from sending print jobs that use another printer language.
Job Waiting Off* On	Preserve print jobs requiring supplies so that jobs not requiring the missing supplies can print. Note: This menu item appears only when a printer hard disk is installed.
Job Hold Timeout 0–255 (30*)	Set the time in seconds that the printer waits for user intervention before it holds jobs that require unavailable resources and continues to print other jobs in the print queue. Note: This menu item appears only when a printer hard disk is installed.
Note: An asterisk (*) next to a value indicates the factory default setting.	

Menu item	Description
Download Target RAM* Disk	Specify where to save all permanent resources, such as fonts and macros, that have been downloaded to the printer. Note: This menu item appears only when a printer hard disk is installed.
Resource Save Off* On	Determine what the printer does with downloaded resources, such as fonts and macros, when it receives a job that requires more than the available memory. Notes: <ul style="list-style-type: none"> • When set to Off, the printer retains downloaded resources only until memory is needed. Resources associated with the inactive printer language are deleted. • When set to On, the printer preserves all the permanent downloaded resources across all language switches. When necessary, the printer shows memory full messages instead of deleting permanent resources.
Print All Order Alphabetical* Newest First Oldest First	Specify the order in which held and confidential jobs are printed when Print All is selected. Note: This menu item appears only when a printer hard disk is installed.
Note: An asterisk (*) next to a value indicates the factory default setting.	

Job Accounting

Note: This menu appears only when a printer hard disk is installed.

Menu item	Description
Job Accounting Off* On	Set the printer to create a log of the print jobs that it receives.
Accounting Log Frequency Daily Weekly Monthly*	Specify how often the printer creates a log file.
Log Action at End of Frequency None* E-mail Current Log E-mail & Delete Current Log Post Current Log Post & Delete Current Log	Specify how the printer responds when the frequency threshold expires. Note: The value defined in Accounting Log Frequency determines when this action is triggered.
Log Near Full Level Off* On	Specify the maximum size of the log file before the printer executes the Log Action at Near Full.
Note: An asterisk (*) next to a value indicates the factory default setting.	

Menu item	Description
Log Action at Near Full None* E-mail Current Log E-mail & Delete Current Log E-mail & Delete Oldest Log Post Current Log Post & Delete Current Log Post & Delete Oldest Log Delete Current Log Delete Oldest Log Delete All But Current Delete All Logs	Specify how the printer responds when the hard disk is nearly full. Note: The value defined in Log Near Full Level determines when this action is triggered.
Log Action at Full None* E-mail & Delete Current Log E-mail & Delete Oldest Log Post & Delete Current Log Post & Delete Oldest Log Delete Current Log Delete Oldest Log Delete All But Current Delete All Logs	Specify how the printer responds when disk usage reaches the maximum limit (100MB).
URL to Post Log	Specify where the printer posts job accounting logs.
E-mail Address to Send Logs	Specify the e-mail address to which the printer sends job accounting logs.
Log File Prefix	Specify the prefix for the log file name. Note: The current host name defined in the TCP/IP menu is used as the default log file prefix.
Note: An asterisk (*) next to a value indicates the factory default setting.	

Quality

Menu item	Description
Print Resolution 300 dpi 600 dpi* 1200 dpi 1200 Image Q 2400 Image Q	Set the resolution for the text and images on the printed output. Note: Resolution is determined in dots per inch or image quality.
Note: An asterisk (*) next to a value indicates the factory default setting.	

Menu item	Description
Pixel Boost Off* Fonts Horizontally Vertically Both directions Isolated	Enable more pixels to print in clusters for clarity, in order to enhance text and images.
Toner Darkness 1–10 (8*)	Determine the lightness or darkness of text images.
Halftone Normal* Detail	Enhance the printed output to have smoother lines with sharper edges.
Brightness -6 to 6 (0*)	Adjust the brightness of the printed output.
Contrast 0 to 5 (0*)	Adjust the contrast of the printed output.
Gray Correction Auto* Off	Adjust the contrast enhancement applied to images.
Note: An asterisk (*) next to a value indicates the factory default setting.	

XPS

Menu item	Description
Print Error Pages Off* On	Print a test page that contains information on errors, including XML markup errors.
Minimum Line Width 1–30 (2*)	Set the minimum stroke width. Notes: <ul style="list-style-type: none"> Jobs printed in 1200 dpi use the value directly. Jobs printed in 4800 CQ use half the value.
Note: An asterisk (*) next to a value indicates the factory default setting.	

PDF

Menu item	Description
Scale to Fit Off* On	Scale the page content to fit the selected paper size.
Note: An asterisk (*) next to a value indicates the factory default setting.	

Menu item	Description
Annotations Do Not Print* Print	Specify whether to print annotations in the PDF.
Note: An asterisk (*) next to a value indicates the factory default setting.	

PostScript

Menu item	Description
Print PS Error On Off*	Print a test page that contains the PostScript error.
Minimum Line Width 1–30 (2*)	Set the minimum stroke width of any job printed in 1200 dpi.
Lock PS Startup Mode On Off*	Disable the SysStart file.
Font Priority Resident* Flash/Disk	Establish the font search order. Notes: <ul style="list-style-type: none"> Resident sets the printer to search its memory for the requested font before searching the flash memory. Flash/Disk sets the printer to search the flash memory for the requested font before searching the printer memory. This menu item appears only when a flash memory is installed.
Wait Timeout Disabled 15–65535 (40*)	Set the printer to wait for additional data before canceling a print job.
Note: An asterisk (*) next to a value indicates the factory default setting.	

PCL

Menu item	Description
Font Source Resident* All	Choose the source which contains the default font selection.
Font Name [List of available fonts]	Select a font from the specified font source.
Note: An asterisk (*) next to a value indicates the factory default setting.	

Menu item	Description
Symbol Set [List of available symbol set]	Specify the symbol set for each font name. Note: A symbol set is a set of alphabetic and numeric characters, punctuation, and special symbols. Symbol sets support the different languages or specific programs such as math symbols for scientific text.
Pitch 0.08–100 (10*)	Specify the font pitch for scalable monospaced fonts. Note: Pitch refers to the number of fixed-space characters in a horizontal inch of type.
Orientation Portrait* Landscape	Specify the orientation of text and graphics on the page.
Lines per Page 1–255	Specify the number of lines of text for each page printed through the PCL® datastream. Notes: <ul style="list-style-type: none"> • This menu item activates vertical escapement that causes the selected number of requested lines to print between the default margins of the page. • 60 is the U.S. factory default setting. 64 is the international factory default setting.
PCL5 Minimum Line Width 1–30 (2*)	Set the initial minimum stroke width. Notes:
PCLXL Minimum Line Width 1–30 (2*)	<ul style="list-style-type: none"> • Jobs printed in 1200 dpi use the value directly. • Jobs printed in 4800CQ use half the value.
A4 Width 198 mm* 203 mm	Set the width of the logical page on A4-size paper. Note: Logical page is the space on the physical page where data is printed.
Auto CR after LF On Off*	Set the printer to perform a carriage return after a line feed control command. Note: Carriage return is a mechanism that commands the printer to move the position of the cursor to the first position on the same line.
Auto LF after CR On Off*	Set the printer to perform a line feed after a carriage return control command.
Note: An asterisk (*) next to a value indicates the factory default setting.	

Menu item	Description
Tray Renumber Assign MP Feeder Off* None 0–201 Assign Tray [x] Off* None 0–201 Assign Manual Paper Off* None 0–201 Assign Manual Envelope Off* None 0–201	Configure the printer to work with print drivers or applications that use different source assignments for the paper source.
Tray Renumber View Factory Defaults	Show the factory default setting assigned for each paper source.
Tray Renumber Restore Defaults	Return all tray assignments to factory default values.
Print Timeout Disabled 1–255 (90*)	Set the printer to end a print job after it has been idle for the specified amount of time in seconds.
Note: An asterisk (*) next to a value indicates the factory default setting.	

HTML

Menu item	Description
Font Name [List of fonts] (Times*)	Set the font to use for HTML documents.
Font Size 1–255 (12*)	Set the font size to use for HTML documents.
Scale 1–400% (100*)	Scale HTML documents.
Orientation Portrait* Landscape	Set the page orientation for HTML documents.
Margin Size 8–255 mm (19*)	Set the page margin for HTML documents.
Note: An asterisk (*) next to a value indicates the factory default setting.	

Menu item	Description
Backgrounds Do Not Print Print*	Print background information or graphics for HTML documents.
Note: An asterisk (*) next to a value indicates the factory default setting.	

Image

Menu item	Description
Auto Fit On Off*	Select the best available paper size and orientation setting for an image. Note: When set to On, this menu item overrides the scaling and orientation settings for the image.
Invert Off* On	Invert bitonal monochrome images. Note: This menu item does not apply to GIF or JPEG image formats.
Scaling Anchor Top Left Best Fit* Anchor Center Fit Height/Width Fit Height Fit Width	Adjust the image to fit the printable area. Note: When Auto Fit is set to On, Scaling is automatically set to Best Fit.
Orientation Portrait* Landscape Reverse Portrait Reverse Landscape	Specify the orientation of text and graphics on the page.
Note: An asterisk (*) next to a value indicates the factory default setting.	

Paper

Tray Configuration

Menu item	Description
Default Source Tray [x] (1*) MP Feeder Manual Paper Manual Envelope	Set the paper source for all print jobs. Note: Multipurpose Feeder only appears when Configure MP is set to Cassette.
Note: An asterisk (*) next to a value indicates the factory default setting.	

Menu item	Description
Paper Size/Type Tray [x] MP Feeder Manual Paper Manual Envelope	Specify the paper size or paper type loaded in each paper source.
Substitute Size Off Statement/A5 Letter/A4 All Listed*	Set the printer to substitute a specified paper size if the requested size is not loaded in any paper source. Notes: <ul style="list-style-type: none"> • Off prompts the user to load the required paper size. • Statement/A5 prints A5-size document on statement when loading statement and statement-size jobs on A5 paper size when loading A5. • Letter/A4 prints A4-size document on letter when loading letter and letter-size jobs on A4 paper size when loading letter. • All Listed substitutes Letter/A4.
Configure MP Cassette* Manual First	Set the printer when to pick paper loaded in the multipurpose feeder. Notes: <ul style="list-style-type: none"> • When set to Cassette, the printer treats the multipurpose feeder like a tray. • When set to Manual, the printer treats the multipurpose feeder like a manual feeder. • When set to First, the printer picks paper from the multipurpose feeder until it is empty, regardless of the required paper source or paper size.
Note: An asterisk (*) next to a value indicates the factory default setting.	

Media Configuration menu

Universal Setup

Menu item	Description
Units of Measure Inches Millimeters	Specify the unit of measurement for the universal paper. Note: Inches is the U.S. factory default setting. Millimeters is the international factory default setting.
Portrait Width 3–52 inches (8.50*) 76–1321 mm (216*)	Set the portrait width of the universal paper.
Portrait Height 3–52 inches (14*) 76–1321 mm (356*)	Set the portrait height of the universal paper.
Note: An asterisk (*) next to a value indicates the factory default setting.	

Menu item	Description
Feed Direction Short Edge* Long Edge	Set the printer to pick paper from the short edge or long edge direction. Note: Long Edge appears only when the longest edge is shorter than the maximum width supported.
Note: An asterisk (*) next to a value indicates the factory default setting.	

Custom Scan Sizes

Menu item	Description
Custom Scan Size [x] Scan Size Name Width 1–8.50 inches (8.50*) 25–216 mm (216*) Height 1–14 inches (14*) 25–356 mm (297*) Orientation Portrait* Landscape 2 scans per side Off* On	Assign a scan size name and configure the scan settings.

Media Types

Menu item	Description
Plain Card Stock Transparency Recycled Labels Bond Envelope Rough Envelope Letterhead Preprinted Colored Paper Light Heavy Rough/Cotton Custom Type [x]	Specify the texture and weight of the paper loaded. Select from the following options: Paper Texture Smooth Normal* Rough Paper Weight Light Normal* Heavy
Note: An asterisk (*) next to a value indicates the factory default setting.	

Copy

Copy Defaults

Menu item	Description
Content Type Text Text/Photo* Photo Graphics	Improve the output result based on the content of the original document.
Content Source Black and White Laser* Color Laser Inkjet Photo/Film Magazine Newspaper Press Other	Improve the output result based on the source of the original document.
Sides (Duplex) 1 sided to 1 sided* 1 sided to 2 sided 2 sided to 1 sided 2 sided to 2 sided	Specify the scanning behavior based on the original document.
Separator Sheets None* Between Copies Between Jobs Between Pages	Specify whether to insert blank separator sheets when printing.
Separator Sheet Source Tray [x] (1*) Multipurpose Feeder	Specify the paper source for the separator sheet.
Pages per Side Off* 2 Portrait pages 4 Portrait pages 2 Landscape pages 4 Landscape pages	Specify the number of page images to print on one side of a sheet of paper.
Print Page Borders Off* On	Place a border around each image when printing multiple pages on a single page.

Note: An asterisk (*) next to a value indicates the factory default setting.

Menu item	Description
Collate Off [1,1,1,2,2,2] On [1,2,1,2,1,2]*	Print multiple copies in sequence.
Copy from Size [List of paper sizes]	Set the paper size of the original document. Notes: <ul style="list-style-type: none"> • Letter is the U.S. factory default setting. A4 is the international factory default setting. • This menu item may vary depending on your printer model.
Copy To Source Tray [x] (1*) Multipurpose Feeder Auto Size Match	Specify the paper source for the copy job.
Darkness -4 to 4 (0*)	Adjust the darkness of the scanned image.
Number of Copies 1–9999 (1*)	Specify the number of copies.
Header/Footer Top left Top middle Top right Bottom left Bottom middle Bottom right	Apply a header or footer on the printed output.
Overlay Confidential Copy Draft Urgent Custom Off*	Specify the overlay text printed on each page of the copy job.
Custom overlay	Type a custom overlay text.
Note: An asterisk (*) next to a value indicates the factory default setting.	

Advanced Imaging

Menu item	Description
<p>Color Dropout None* Red Green Blue</p> <p>Default Red Threshold 0–255 (128*)</p> <p>Default Green Threshold 0–255 (128*)</p> <p>Default Blue Threshold 0–255 (128*)</p>	<p>Specify which color to drop during scanning, and adjust the dropout setting for that color.</p>
<p>Contrast Best for Content* 0 1 2 3 4 5</p>	<p>Specify the contrast of the output.</p>
<p>Background Removal Background Detection Level</p>	<p>Adjust the amount of background visible on a scanned image.</p>
<p>Auto Center Off* On</p>	<p>Align the content at the center of the page.</p>
<p>Mirror Image Off* On</p>	<p>Create a mirror image of the original document.</p>
<p>Negative Image Off* On</p>	<p>Create a negative image of the original document.</p>
<p>Shadow Detail -4 to 4 (0*)</p>	<p>Adjust the amount of shadow detail visible on a scanned image.</p>
<p>Scan Edge to Edge Off* On</p>	<p>Allow edge-to-edge scanning of the original document.</p>
<p>Sharpness 1–5 (3*)</p>	<p>Adjust the sharpness of a scanned image.</p>
<p>Note: An asterisk (*) next to a value indicates the factory default setting.</p>	

Admin Controls

Menu item	Description
Transparency Separators Off On*	Insert a blank sheet between transparencies.
Allow Priority Copies Off On*	Interrupt a print job to copy a page or document.
Custom Job Scanning Off* On	Turn on scanning of custom jobs by default.
Allow Save as Shortcut Off On*	Save custom copy settings as shortcuts.
Sample Copy	Print a sample copy.
Note: An asterisk (*) next to a value indicates the factory default setting.	

Fax

Fax Mode

Menu item	Description
Fax Mode Analog* Fax Server Disabled	Select a fax mode.
Note: An asterisk (*) next to a value indicates the factory default setting.	

Analog Fax Setup

General Fax Settings

Menu item	Description
Fax Name	Identify your fax machine.
Fax Number	Identify your fax number.
Fax ID Fax Name Fax Number*	Notify fax recipients of your fax name or fax number.
Note: An asterisk (*) next to a value indicates the factory default setting.	

Menu item	Description
Enable Manual Fax Off* On	Set the printer to fax manually. Notes: <ul style="list-style-type: none"> • This menu item does not appear if Fax Transport is set to T.38 or G711. • This menu item requires a line splitter and a telephone handset. • Use a regular telephone line to answer an incoming fax job and to dial a fax number. • To go directly to the Manual Fax function, touch # and 0 on the keypad.
Memory Use All receive Mostly receive Equal* Mostly send All send	Set the amount of internal printer memory allocated for faxing. Note: This menu item prevents memory buffer conditions and failed faxes.
Cancel Faxes Allow* Don't Allow	Cancel outgoing faxes before they are transmitted, or cancel incoming faxes before they finish printing.
Caller ID Off On* Alternate	Show the telephone number of the person sending the fax.
Fax Number Masking Off* From Left From Right	Specify the format for masking an outgoing fax number.
Digits to Mask 0–58 (0*)	Specify the number of digits to mask in an outgoing fax number.
Enable Line Connected Detection Off On*	Determine whether a telephone line is connected to the printer. Notes: <ul style="list-style-type: none"> • Detection takes place when turning on the printer and before each call. • This menu item does not appear if Fax Transport is set to T.38.
Enable Line In Wrong Jack Detection Off* On	Determine whether a telephone line is connected to the correct port on the printer. Notes: <ul style="list-style-type: none"> • Detection takes place when turning on the printer and before each call. • This menu item does not appear if Fax Transport is set to T.38.
Note: An asterisk (*) next to a value indicates the factory default setting.	

Menu item	Description
Enable Extension in Use Support Off On*	Determine whether a telephone line is used by another device such as another phone on the same line. Notes: <ul style="list-style-type: none"> • This menu item is monitored continuously after turning on the printer. • This menu item does not appear if Fax Transport is set to T.38.
Optimize Fax Compatibility	Configure the printer fax functionality for optimal compatibility with other fax machines.
Note: An asterisk (*) next to a value indicates the factory default setting.	

Fax Send Settings

Menu item	Description
Resolution Standard* Fine Super Fine Ultra Fine	Set the resolution of the scanned image. Note: A higher resolution increases fax transmission time and requires higher memory.
Original Size [List of paper sizes]	Specify the size of the original document. Note: Mixed Sizes is the U.S. factory default setting. A4 is the international factory default setting.
Orientation Portrait* Landscape	Specify the orientation of the original document.
Sides Off* Long Edge Short Edge	Specify the page orientation of text and graphics when scanning a two-sided document.
Content Type Text* Text/Photo Photo Graphics	Improve the output result based on the content of the original document.
Content Source Black and White Laser* Color Laser Inkjet Photo/Film Magazine Newspaper Press Other	Improve the output result based on the source of the original document.
Note: An asterisk (*) next to a value indicates the factory default setting.	

Menu item	Description
Darkness -4 to 4 (0*)	Adjust the darkness of the scanned image.
Behind a PABX Off* On	Set the printer to dial a fax number without waiting to recognize the dial tone. Note: Private Automated Branch Exchange (PABX) is a telephone network that allows a single access number to offer multiple lines to outside callers.
Dial Mode Tone* Pulse	Specify the dial mode for incoming or outgoing faxes.
Note: An asterisk (*) next to a value indicates the factory default setting.	

Advanced Imaging

Menu item	Description
Color Balance -4 to 4 (0*)	Adjust the amount of toner used for each color.
Color Dropout None* Red Green Blue Default Red Threshold 0–255 (128*) Default Green Threshold 0–255 (128*) Default Blue Threshold 0–255 (128*)	Specify which color to drop during scanning, and adjust the dropout setting for that color.
Contrast Best for Content* 0 1 2 3 4 5	Set the contrast of the output.
Background Removal Background Detection Content-based* Fixed Level -4 to 4 (0*)	Adjust the amount of background visible on a scanned image. Note: If you want to remove the background color from the original document, then set Background Detection to Content-based. If you want to remove image noise from a photo, then set Background Detection to Fixed.
Note: An asterisk (*) next to a value indicates the factory default setting.	

Menu item	Description
Mirror Image Off* On	Create a mirror image of the original document.
Negative Image Off* On	Create a negative image of the original document.
Shadow Detail -4 to 4 (0*)	Adjust the amount of shadow detail visible on a scanned image.
Scan Edge to Edge Off* On	Allow edge-to-edge scanning of the original document.
Sharpness 1–5 (3*)	Adjust the sharpness of the scanned image.
Temperature -4 to 4 (0*)	Specify whether to generate a cooler or warmer output.
Note: An asterisk (*) next to a value indicates the factory default setting.	

Admin Controls

Menu item	Description
Automatic Redial 0–9 (5*)	Adjust the number of redial attempts based on the activity levels of recipient fax machines.
Redial Frequency 1–200 minutes (3*)	Increase the time between redial attempts to increase the chance of sending fax successfully.
Enable ECM Off On*	Activate Error Correction Mode (ECM) for fax jobs. Note: ECM detects and corrects errors in the fax transmission process that are caused by telephone line noise and poor signal strength.
Enable Fax Scans Off On*	Fax documents that are scanned at the printer.
Driver to Fax Off On*	Allow the print driver to send fax.
Allow Save as Shortcut Off On*	Save fax numbers as shortcuts in the printer.
Note: An asterisk (*) next to a value indicates the factory default setting.	

Menu item	Description
Max Speed 33600* 14400 9600 4800 2400	Set the maximum speed for sending fax.
Custom Job Scanning Off* On	Turn on scanning of custom jobs by default. Note: This menu item appears only when a hard disk is installed.
Scan Preview Off* On	Show a preview of the scan on the display. Note: This menu item appears only when a hard disk is installed.
Enable Color Fax Scans Off by default* On by default Never use Always use	Enable color scans for fax.
Auto Convert Color Faxes to Mono Faxes Off On*	Convert all outgoing color faxes to black and white.
Confirm Fax Number Off* On	Ask the user to confirm the fax number.
Dial Prefix	Set a dialing prefix.
Dialing Prefix Rules Prefix Rule [x]	Establish a dialing prefix rule.
Note: An asterisk (*) next to a value indicates the factory default setting.	

Fax Receive Settings

Menu item	Description
Fax Job Waiting None* Toner Toner and Supplies	Remove fax jobs that request specific unavailable resources from the print queue.
Rings to Answer 1–25 (3*)	Set the number of rings for incoming fax.
Note: An asterisk (*) next to a value indicates the factory default setting.	

Menu item	Description
Auto Reduction Off On*	Scale incoming fax to fit on the page.
Paper Source Tray [x] Multipurpose Feeder Auto*	Set the paper source for printing incoming fax.
Sides Off* On	Print on both sides of the paper.
Separator Sheets None* Before Job After Job	Specify whether to insert blank separator sheets when printing.
Separator Sheet Source Tray [x] (1*) Multipurpose Feeder	Specify the paper source for the separator sheet.
Output Bin Standard Bin	Specify the output bin for received faxes.
Fax Footer On Off*	Print the transmission information at the bottom of each page from a received fax.
Fax Footer Time Stamp Receive* Print	Print the time stamp at the bottom of each page from a received fax.
Holding Faxes Held Fax Mode Off* Always On Manual Scheduled	Hold received faxes from printing until they are released.

Note: An asterisk (*) next to a value indicates the factory default setting.

Admin Controls

Menu item	Description
Enable Fax Receive Off On*	Set the printer to receive fax.

Note: An asterisk (*) next to a value indicates the factory default setting.

Menu item	Description
Enable Color Fax Receive Off On*	Set the printer to receive fax in color.
Enable Caller ID Off On*	Show the number that is sending the incoming fax.
Block No Name Fax Off* On	Block incoming faxes sent from devices with no station ID or fax ID specified.
Banned Fax List Add Banned Fax	Specify the phone numbers that you want to block.
Answer On All Rings* Single Ring Only Double Ring Only Triple Ring Only Single or Double Rings Only Single or Triple Rings Only Double or Triple Rings Only	Set a distinctive ring pattern for incoming fax.
Auto Answer Off On*	Set the printer to receive fax automatically.
Manual Answer Code 0–9 (9*)	Manually enter a code on the telephone number pad to begin receiving fax. Notes: <ul style="list-style-type: none"> • This menu item appears only when the printer shares a line with a telephone. • This menu item appears only when you set the printer to receive fax manually.
Fax Forwarding Print* Print and Forward Forward	Specify how to forward received fax.
Forward to Destination [x] Type Shortcut Number	Specify where to forward received fax.
Confirmation E-mail	Send a confirmation e-mail when fax forwarding is successful. Note: The e-mail is sent only when forwarding to FTP or Network Share destinations.
Note: An asterisk (*) next to a value indicates the factory default setting.	

Menu item	Description
Max Speed 33600* 14400 9600 4800 2400	Set the maximum speed for transmitting fax.
Note: An asterisk (*) next to a value indicates the factory default setting.	

Fax Cover Page

Menu item	Description
Fax Cover Page Off by Default* On by Default Never Use Always Use	Configure the settings for the fax cover page.
Include To field Off* On	
Include From field Off* On	
From	
Include Message Field Off* On	
Message:	
Include Logo Off* On	
Include Footer [x] Off* On	
Footer [x]	
Note: An asterisk (*) next to a value indicates the factory default setting.	

Fax Log Settings

Menu item	Description
Transmission Log Print log* Do Not Print Log Print Only For Error	Print a log for successful fax transmission or transmission error.
Receive Error Log Print Never* Print on Error	Print a log for fax-receive failures.
Auto Print Logs On* Off	Print all fax activity.
Log Paper Source Tray [x] (1*) Multipurpose Feeder	Specify the paper source for printing logs.
Logs Display Remote Fax Name* Dialed Number	Identify the sender by remote fax name or fax number.
Enable Job Log On* Off	View a summary of all fax jobs.
Enable Call Log On* Off	View a summary of fax dialing history.
Log Output Bin Standard Bin* Bin [x]	Specify the output bin for printed logs.
Note: An asterisk (*) next to a value indicates the factory default setting.	

Speaker Settings

Menu item	Description
Speaker Mode Always Off Always On On until Connected*	Set the fax speaker mode.
Speaker Volume Low* High	Adjust the fax speaker volume.
Note: An asterisk (*) next to a value indicates the factory default setting.	

Menu item	Description
Ringer Volume Off On*	Enable the ringer volume.
Note: An asterisk (*) next to a value indicates the factory default setting.	

Fax Server Setup

General Fax Settings

Menu item	Description
To Format	Specify a fax recipient. Note: If you want to use the fax number, then type the number sign (#) before a number.
Reply Address	Specify a reply address for sending fax.
Subject	Specify the fax subject and message.
Message	
Enable analog receive Off* On	Set the printer to receive analog faxes.
Note: An asterisk (*) next to a value indicates the factory default setting.	

Fax Server E-mail Settings

Menu item	Description
Primary SMTP Gateway	Type the IP address or host name of the primary Simple Mail Transfer Protocol (SMTP) server for sending e-mail.
Primary SMTP Gateway Port 1–65535 (25*)	Enter the port number of the primary SMTP server.
Secondary SMTP Gateway	Type the server IP address or host name of your secondary or backup SMTP server.
Secondary SMTP Gateway Port 1–65535 (25*)	Enter the server port number of your secondary or backup SMTP server.
SMTP Timeout 5–30 (30*)	Set the time before the printer times out if the SMTP server does not respond.
Reply Address	Specify a reply address for sending fax.
Always use SMTP default Reply Address Off On*	Specify the SMTP reply address for sending fax.
Note: An asterisk (*) next to a value indicates the factory default setting.	

Menu item	Description
Use SSL/TLS Disabled* Negotiate Required	Specify whether to send fax using an encrypted link.
Require Trusted Certificate Off On*	Specify a trusted certificate when accessing the SMTP server.
SMTP Server Authentication No authentication required* Login / Plain NTLM CRAM-MD5 Digest-MD5 Kerberos 5	Set the authentication type for the SMTP server.
Device-Initiated E-mail None* Use Device SMTP Credentials	Specify whether credentials are required for device-initiated e-mail.
User-Initiated E-mail None* Use Device SMTP Credentials Use Session User ID and Password Use Session E-mail address and Password Prompt user	Specify whether credentials are required for user-initiated e-mail.
Use Active Directory Device Credentials Off On*	Enable user credentials and group destinations to connect to the SMTP server.
Device Userid	Specify the user ID and password to connect to the SMTP server.
Device Password	
Kerberos 5 REALM	Specify the realm for the Kerberos 5 authentication protocol.
NTLM Domain	Specify the domain name for the NTLM security protocol.
Disable "SMTP server not set up" error Off* On	Hide the "SMTP server not set up" error message.
Note: An asterisk (*) next to a value indicates the factory default setting.	

Fax Server Scan Settings

Menu item	Description
Image Format TIFF (.tif) PDF (.pdf)* XPS (.xps) TXT (.txt) RTF (.rtf) DOCX (.docx)	Specify the file format for the scanned image.
Content Type Text Text/Photo* Photo Graphics	Improve the output result based on the content of the original document.
Content Source Black and White Laser Color Laser* Inkjet Photo/Film Magazine Newspaper Press Other	Improve the output result based on the source of the original document.
Fax Resolution Standard* Fine Super Fine Ultra Fine	Set the fax resolution.
Darkness 1–9 (5*)	Set the darkness of the output.
Orientation Portrait* Landscape	Specify the orientation of text and graphics on the page.
Original Size [List of paper sizes]	Set the paper size of the original document. Notes: <ul style="list-style-type: none"> • Mixed Sizes is the U.S. factory default setting. A4 is the international factory default setting. • This setting may vary depending on your printer model.
Use Multi-Page TIFF Off On*	Choose between single- and multiple-page TIFF files.
Note: An asterisk (*) next to a value indicates the factory default setting.	

E-mail

E-mail Setup

Menu item	Description
Primary SMTP Gateway	Type the IP address or host name of the primary SMTP server for sending e-mail.
Primary SMTP Gateway Port 1–65535 (25*)	Enter the port number of the primary SMTP server.
Secondary SMTP Gateway	Type the server IP address or host name of your secondary or backup SMTP server.
Secondary SMTP Gateway Port 1–65535 (25*)	Enter the server port number of your secondary or backup SMTP server.
SMTP Timeout 5–30 seconds (30*)	Set the time before the printer times out if the SMTP server does not respond.
Reply Address	Specify a reply address in the e-mail.
Always use SMTP default Reply Address On* Off	Always use the default reply address in the SMTP server.
Use SSL/TLS Disabled* Negotiate Required	Specify whether to send e-mail using an encrypted link.
Require Trusted Certificate Off On*	Require a trusted certificate when accessing the SMTP server.
SMTP Server Authentication No authentication required* Login / Plain NTLM CRAM-MD5 Digest-MD5 Kerberos 5	Set the authentication type for the SMTP server.
Device-Initiated E-mail None* Use Device SMTP Credentials	Specify whether credentials are required for device-initiated e-mail.
Note: An asterisk (*) next to a value indicates the factory default setting.	

Menu item	Description
User-Initiated E-mail None* Use Device SMTP Credentials Use Session User ID and Password Use Session E-mail address and Password Prompt user	Specify whether credentials are required for user-initiated e-mail.
Use Active Directory Device Credentials Off On*	Enable user credentials and group designations to connect to the SMTP server.
Device Userid	Specify the user ID and password to connect to the SMTP server.
Device Password	
Kerberos 5 REALM	Specify the realm for the Kerberos 5 authentication protocol.
NTLM Domain	Specify the domain name for the NTLM security protocol.
Disable "SMTP server not set up" error Off* On	Hide the "SMTP server not set up" error message.
Note: An asterisk (*) next to a value indicates the factory default setting.	

E-mail Defaults

Menu item	Description
Subject	Specify the e-mail subject and message.
Message	
File Name	Specify the file name for the scanned image.
Format PDF (.pdf)* TIFF (.tif) JPEG (.jpg) XPS (.xps) TXT (.txt) RTF (.rtf) DOC (.docx)	Specify the file format for the scanned image.
Note: An asterisk (*) next to a value indicates the factory default setting.	

Menu item	Description
Global OCR Settings Recognized Languages Auto Rotate Despeckle Auto Contrast Enhance	Configure the settings for optical character recognition (OCR). Note: This menu item appears only if you have purchased and installed an OCR solution.
PDF Settings PDF Version 1.3 1.4 1.5* 1.6 1.7 Archival Version A-1a* A-1b Highly Compressed Off* On Secure Off* On Searchable Off* On Archival (PDF/A) Off* On	Set the PDF format of the scanned image.
Content Type Text Text/Photo* Photo Graphics	Improve the output result based on the content of the original document.
Content Source Black and White Laser* Color Laser Inkjet Photo/Film Magazine Newspaper Press Other	Improve the output result based on the original document.
Note: An asterisk (*) next to a value indicates the factory default setting.	

Menu item	Description
Color Black and White Gray Color* Auto	Specify the color when scanning an image.
Resolution 75 dpi 150 dpi* 200 dpi 300 dpi 400 dpi 600 dpi	Set the resolution of the scanned image.
Darkness -4 to 4 (0*)	Adjust the darkness of the scanned image.
Orientation Portrait* Landscape	Specify the orientation of text and graphics on the page.
Original Size [List of paper sizes]	Set the paper size of the original document. Note: Mixed Sizes is the factory default setting.
Sides Off* Long Edge Short Edge	Specify the page orientation of text and graphics when scanning a two-sided document.
Note: An asterisk (*) next to a value indicates the factory default setting.	

Advanced Imaging

Menu item	Description
Color Balance -4 to 4 (0*)	Adjust the amount of toner being used for each color.
Color Dropout Color Dropout None* Red Green Blue Default Red Threshold 0–255 (128*) Default Green Threshold 0–255 (128*) Default Blue Threshold 0–255 (128*)	Specify which color to drop during scanning, and adjust the dropout setting for that color.
Note: An asterisk (*) next to a value indicates the factory default setting.	

Menu item	Description
Auto Color Detect Color Sensitivity 1–9 (5*) Area Sensitivity 1–9 (5*)	Set the amount of color that the printer detects from the original document. Note: This menu item appears only when Color is set to Auto.
JPEG Quality Best for content* 5–95	Set the quality of a JPEG-format scanned image. Notes: <ul style="list-style-type: none"> • 5 reduces the file size, but lessens the image quality. • 95 provides the best image quality, but produces a large file size.
Contrast Best for content* 0 1 2 3 4 5	Specify the contrast of the output.
Background Removal Background Detection Content-based* Fixed Level -4 to 4 (0*)	Adjust the amount of background visible on a scanned image. Note: If you want to remove the background color from the original document, then set Background Detection to Content-based. If you want to remove image noise from a photo, then set Background Detection to Fixed.
Mirror Image Off* On	Create a mirror image of the original document.
Negative Image Off* On	Create a negative image of the original document.
Shadow Detail -4 to 4 (0*)	Adjust the amount of shadow detail visible on a scanned image.
Scan Edge to Edge Off* On	Allow edge-to-edge scanning of the original document.
Sharpness 1–5 (3*)	Adjust the sharpness of a scanned image.
Temperature -4 to 4 (0*)	Specify whether to generate a cooler or warmer output.
Note: An asterisk (*) next to a value indicates the factory default setting.	

Menu item	Description
Blank Pages Blank Page Removal Blank Page Sensitivity	Specify whether to include blank pages.
Note: An asterisk (*) next to a value indicates the factory default setting.	

Admin Controls

Menu item	Description
Max E-mail Size 0–65535 (0*)	Set the allowable file size for each e-mail.
Size Error Message	Specify an error message that the printer sends when an e-mail exceeds its allowable file size. Note: You can type up to 1024 characters.
Limit Destinations	Limit sending of e-mail only to the specified list of domain names. Note: Use a comma to separate each domain.
Send Me a Copy Never appears* On by Default Off by Default Always On	Send a copy of the e-mail to yourself.
Limit E-mail Recipients Off* On	Limit the number of e-mail recipients.
Use cc:/bcc: Off* On	Enable carbon copy and blind carbon copy in e-mail.
Use Multi-Page TIFF On* Off	Choose between single- and multiple-page TIFF files.
TIFF Compression LZW* JPEG	Set a compression option for TIFF files.
Text Default 5–95 (75*)	Set the quality of text on a scanned image.
Text/Photo Default 5–95 (75*)	Set the quality of text or photo on a scanned image.
Photo Default 5–95 (50*)	Set the quality of a photo on a scanned image.
Note: An asterisk (*) next to a value indicates the factory default setting.	

Menu item	Description
E-mail Bit Depth 1 bit 8 bit*	Enable the Text/Photo mode to produce smaller file sizes by using 1-bit image. Note: This menu item appears only when Color is set to Gray.
Transmission Log Print log* Do Not Print Log Print Only For Error	Print a log for successful e-mail transmission.
Log Paper Source Tray [x] (1*) Multipurpose Feeder	Specify the paper source for printing logs.
Custom Job Scanning Off* On	Turn on scanning of custom jobs by default. Note: This menu item appears only when a hard disk is installed.
Scan Preview Off On*	Show the scan preview on the display. Note: This menu item appears only when a printer hard disk is installed.
Allow Save as Shortcut Off On*	Save e-mail addresses as shortcuts. Note: When set to Off, the Save As Shortcut button does not appear on the e-mail Destination screen.
E-mail Images Sent As Attachment* Web Link	Specify how to send the images in e-mail.
Reset E-mail Information After Sending Off On*	Restore the default e-mail information after sending an e-mail.
Note: An asterisk (*) next to a value indicates the factory default setting.	

Web Link Setup

Menu item	Description
Server	Set the printer to send e-mail as a web link.
Login	
Password	
Path	
File Name	
Web Link	

FTP

FTP Defaults

Menu item	Description
<p>Format</p> <ul style="list-style-type: none"> PDF (.pdf)* TIFF (.tif) JPEG (.jpg) XPS (.xps) TXT (.txt) RTF (.rtf) DOCX (.docx) 	<p>Specify the file format for the scanned image.</p> <p>Note: The menu items may vary depending on your printer model.</p>
<p>Global OCR Settings</p> <ul style="list-style-type: none"> Recognized Languages Auto Rotate Despeckle Auto Contrast Enhance 	<p>Configure the settings for optical character recognition (OCR).</p> <p>Note: This menu appears only if you have purchased and installed an OCR solution.</p>
<p>PDF Settings</p> <ul style="list-style-type: none"> PDF Version <ul style="list-style-type: none"> 1.3 1.4 1.5* 1.6 1.7 Archival Version <ul style="list-style-type: none"> A-1a* A-1b Secure <ul style="list-style-type: none"> Off* On Archival (PDF/A) <ul style="list-style-type: none"> Off* On 	<p>Set the PDF format for the scanned image.</p>
<p>Content Type</p> <ul style="list-style-type: none"> Text Text/Photo* Graphics Photo 	<p>Improve the output result based on the content of the original document.</p>
<p>Note: An asterisk (*) next to a value indicates the factory default setting.</p>	

Menu item	Description
<p>Content Source Black and White Laser Color Laser* Inkjet Photo/Film Magazine Newspaper Press Other</p>	<p>Improve the output result based on the source of the original document.</p>
<p>Color Black and White Gray Color* Auto</p>	<p>Specify the color when scanning an image.</p>
<p>Resolution 75 dpi 150 dpi* 200 dpi 300 dpi 400 dpi 600 dpi</p>	<p>Set the resolution of the scanned image.</p>
<p>Darkness -4 to 4 (0*)</p>	<p>Adjust the darkness of the scanned image.</p>
<p>Orientation Portrait* Landscape</p>	<p>Specify the orientation of text and graphics on the page.</p>
<p>Original Size [List of paper sizes]</p>	<p>Set the paper size of the original document.</p> <p>Notes:</p> <ul style="list-style-type: none"> • Letter is the U.S. factory default setting. A4 is the international factory default setting. • The menu items may vary depending on your printer model.
<p>Sides Off* Long Edge Short Edge</p>	<p>Specify the page orientation of text and graphics when scanning a two-sided document.</p>
<p>File Name</p>	<p>Specify the file name of the scanned image.</p>
<p>Note: An asterisk (*) next to a value indicates the factory default setting.</p>	

Advanced Imaging

Menu item	Description
Color Balance -4 to 4 (0*)	Adjust the amount of toner used for each color in scan output.
Color Dropout Color Dropout None* Red Green Blue Default Red Threshold 0–255 (128*) Default Green Threshold 0–255 (128*) Default Blue Threshold 0–255 (128*)	Specify which color to drop during scanning, and adjust the dropout setting for that color.
Auto Color Detect Color Sensitivity 1–9 (5*) Area Sensitivity 1–9 (5*)	Set the amount of color that the printer detects from the original document. Note: This menu item appears only when Color is set to Auto.
JPEG Quality Best for content* 5–95	Set the quality of a JPEG-format image. Notes: <ul style="list-style-type: none"> • 5 reduces the file size, but lessens the image quality. • 90 provides the best image quality, but produces a large file size.
Contrast Best for content* 0 1 2 3 4 5	Specify the contrast of the output.
Background Removal Background Detection Content-based* Fixed Level -4 to 4 (0*)	Adjust the amount of background visible on a scanned image. Note: If you want to remove the background color from the original document, then set Background Detection to Content-based. If you want to remove image noise from a photo, then set Background Detection to Fixed.
Mirror Image Off* On	Create a mirror image of the original document.
Note: An asterisk (*) next to a value indicates the factory default setting.	

Menu item	Description
Negative Image Off* On	Create a negative image of the original document.
Shadow Detail -4 to 4 (0*)	Adjust the amount of shadow detail visible on a scanned image.
Scan Edge to Edge Off* On	Allow edge-to-edge scanning of the original document.
Sharpness 1–5 (3*)	Adjust the sharpness of a scanned image.
Temperature -4 to 4 (0*)	Specify whether to generate a cooler or warmer output.
Blank Pages Blank Page Removal Blank Page Sensitivity	Specify whether to include blank pages.
Note: An asterisk (*) next to a value indicates the factory default setting.	

Admin Controls

Menu item	Description
Text Default 5–95 (75*)	Set the quality of text on a scanned image.
Text/Photo Default 5–95 (75*)	Set the quality of text or photo image on a scanned image.
Photo Default 5–95 (50*)	Set the quality of a photo image on a scanned image.
Use Multi-Page TIFF On* Off	Choose between single- and multiple-page TIFF files.
TIFF Compression LZW* JPEG	Set a compression option for TIFF files.
Transmission Log Print Log* Do Not Print Log Print Only For Error	Print a log for successful FTP scan transmission.
Log Paper Source Tray [x] (1*) Multipurpose Feeder	Specify the paper source for printing FTP logs.
Note: An asterisk (*) next to a value indicates the factory default setting.	

Menu item	Description
FTP Bit Depth 1 bit 8 bit*	Enable the Text/Photo mode to have smaller file sizes by using 1-bit image. Note: This menu item appears only when Color is set to Gray.
Custom Job Scanning Off* On	Turn on scanning of custom jobs by default. Note: This menu item appears only when a hard disk is installed.
Scan Preview Off On*	Show a preview of the scan on the display. Note: This menu item appears only when a hard disk is installed.
Allow Save as Shortcut Off On*	Save custom FTP settings as shortcuts.
Note: An asterisk (*) next to a value indicates the factory default setting.	

Network/Ports

Network Overview

Menu item	Description
Active Adapter Auto* Standard Network	Specify how a network is connected.
Network Status	Show the connection status of the printer network.
Display Network Status on Printer On* Off	Show the network status on the display.
Speed, Duplex	Show the speed of the currently active network card.
IPv4	Show the IPv4 address.
All IPv6 Addresses	Show all IPv6 addresses.
Reset Print Server	Reset all active network connections to the printer. Note: This setting removes all network configuration settings.
Network Job Timeout Off On* (90 seconds)	Set the time before the printer cancels a network print job.
Banner Page Off* On	Print a banner page.
Note: An asterisk (*) next to a value indicates the factory default setting.	

Menu item	Description
Scan to PC Port Range 9751:12000*	Specify a valid port range for printers that are behind a port blocking firewall.
Note: An asterisk (*) next to a value indicates the factory default setting.	

Wireless

Note: This menu is available only in printers connected to a Wi-Fi network or printers that have a wireless network adapter.

Menu item	Description
Setup On Printer Panel Choose Network Add Wi-Fi Network Network Name Network Mode Infrastructure Wireless Security Mode Disabled* WEP WPA2/WPA - Personal WPA2 - Personal 802.1x - RADIUS	Configure the Wi-Fi connection using the control panel. Note: 802.1x - RADIUS can be configured only from the Embedded Web Server.
Wi-Fi Protected Setup WPS Auto Detect Off On* Start Push Button Method Start PIN Method	Establish a Wi-Fi network and enable network security. Notes: <ul style="list-style-type: none"> • WPS Auto Detect appears only when the Wireless Security Mode is set to WEP. • Start Push-Button Method connects the printer to a Wi-Fi network when buttons on both the printer and the access point (wireless router) are pressed within a given time. • Start PIN Method connects the printer to a Wi-Fi network when a PIN on the printer is entered into the wireless settings of the access point.
Network Mode BSS Type Infrastructure*	Specify the network mode.
Enable Wi-Fi Direct On Off*	Enable Wi-Fi Direct-capable devices to connect directly to the printer.
Compatibility 802.11b/g/n (2.4GHz)* 802.11a/b/g/n/ac (2.4GHz/5GHz) 802.11a/n/ac (5GHz)	Specify the standard for the Wi-Fi network. Note: 802.11a/b/g/n/ac (2.4GHz/5GHz) and 802.11a/n/ac (5GHz) only appear when a Wi-Fi option is installed.

Menu item	Description
Wireless Security Mode Disabled* WEP WPA2/WPA-Personal WPA2-Personal 802.1x - RADIUS	Set the security mode for connecting the printer to Wi-Fi devices. Note: 802.1x - RADIUS can be configured only from the Embedded Web Server.
WEP Authentication Mode Auto* Open Shared	Set the type of Wireless Encryption Protocol (WEP) for the printer. Note: This menu item appears only when the Wireless Security Mode is set to WEP.
Set WEP Key	Specify a WEP password for secure Wi-Fi connection.
WPA2/WPA Personal AES	Enable Wi-Fi security through Wi-Fi Protected Access (WPA). Note: This menu item appears only when the Wireless Security Mode is set to WPA2/WPA-Personal.
Set Pre-Shared Key	Set the password for secure Wi-Fi connection.
WPA2-Personal AES	Enable Wi-Fi security through WPA2. Note: This menu item appears only when the Wireless Security Mode is set to WPA2-Personal.
802.1x Encryption Mode WPA+ WPA2*	Enable Wi-Fi security through 802.1x standard. Notes: <ul style="list-style-type: none"> • This menu item appears only when the Wireless Security Mode is set to 802.1x - RADIUS. • 802.1x - RADIUS can be configured only from the Embedded Web Server.
IPv4 Enable DHCP On* Off Set Static IP Address IP Address Netmask Gateway	Enable and configure IPv4 settings in the printer.

Menu item	Description
IPv6 Enable IPv6 On* Off Enable DHCPv6 On Off* Stateless Address Autoconfiguration On* Off DNS Server Address Manually Assigned IPv6 Address Manually Assigned IPv6 Router Address Prefix All IPv6 Addresses All IPv6 Router Addresses	Enable and configure IPv6 settings in the printer.
Network Address UAA LAA	View the network addresses.
PCL SmartSwitch Off On*	Set the printer to switch automatically to PCL emulation when a print job requires it, regardless of the default printer language. Note: If PCL SmartSwitch is off, then the printer does not examine incoming data and uses the default printer language specified in the Setup menu.
PS SmartSwitch Off On*	Set the printer to switch automatically to PS emulation when a print job requires it, regardless of the default printer language. Note: If PS SmartSwitch is off, then the printer does not examine incoming data and uses the default printer language specified in the Setup menu.
Job Buffering On Off*	Temporarily store print jobs in the printer hard disk before printing. Note: This menu item appears only when a hard disk is installed.
Mac Binary PS Auto* On Off	Set the printer to process Macintosh binary PostScript print jobs. Notes: <ul style="list-style-type: none"> • On processes raw binary PostScript print jobs. • Off filters print jobs using the standard protocol.

Ethernet

Menu item	Description
Network Speed	Show the speed of an active network adapter.
Note: An asterisk (*) next to a value indicates the factory default setting.	

Menu item	Description
IPv4 Enable DHCP On* Off	Enable Dynamic Host Configuration Protocol (DHCP). Note: DHCP is a standard protocol that allows a server to dynamically distribute IP addressing and configuration information to clients.
IPv4 Set Static IP Address IP Address Netmask Gateway	Set the static IP address of your printer.
Enable IPv6 On* Off	Configure IPv6 in the printer.
Enable DHCPv6 On Off*	Run DHCPv6 in an IPv6 network.
Stateless Address Autoconfiguration On* Off	Set the network adapter to accept the automatic IPv6 address configuration entries provided by a router.
DNS Address	Specify the DNS server address, IP address, and the router for IPv6 network.
Manually Assigned IPv6 Address	
Manually Assigned IPv6 Router	
Address Prefix 0–128 (64*)	
All IPv6 Addresses	Show all IP and router addresses used in an IPv6 network.
All IPv6 Router Addresses	
Network Address UAA LAA	Show the printer Media Access Control (MAC) addresses: Locally Administered Address (LAA) and Universally Administered Address (UAA). Note: You can change the printer LAA manually.
PCL SmartSwitch On* Off	Set the printer to switch automatically to PCL emulation when a print job requires it, regardless of the default printer language. Note: If PCL SmartSwitch is off, then the printer does not examine incoming data and uses the default printer language specified in the Setup menu.
PS SmartSwitch On* Off	Set the printer to switch automatically to PS emulation when a print job requires it, regardless of the default printer language. Note: If PS SmartSwitch is off, then the printer does not examine incoming data and uses the default printer language specified in the Setup menu.
Note: An asterisk (*) next to a value indicates the factory default setting.	

Menu item	Description
Mac Binary PS Auto* On Off	Set the printer to process Macintosh binary PostScript print jobs. Notes: <ul style="list-style-type: none"> • On processes raw binary PostScript print jobs. • Off filters print jobs using the standard protocol.
Energy Efficient Ethernet On* Off	Reduce power consumption when the printer receives no data from the Ethernet network.
Note: An asterisk (*) next to a value indicates the factory default setting.	

TCP/IP

Note: This menu appears only in network printers or printers attached to print servers.

Menu item	Description
Set Hostname	Set the current TCP/IP host name.
Domain Name	Set the domain name.
Allow DHCP/BOOTP to update NTP server On* Off	Allow the DHCP and BOOTP clients to update the NTP settings of the printer.
Zero Configuration Name	Specify a service name for the zero configuration network.
Enable Auto IP On* Off	Assign an IP address automatically.
DNS Address	Specify the current Domain Name System (DNS) server address.
Backup DNS Address	Specify the backup DNS server addresses.
Backup DNS Address 2	
Backup DNS Address 3	
Domain Search Order	Specify a list of domain names to locate the printer and its resources that reside in different domains on the network.
Enable DDNS On* Off	Update Dynamic DNS settings.
DDNS TTL	Specify the current DDNS settings.
Default TTL	
DDNS Refresh Time	
Note: An asterisk (*) next to a value indicates the factory default setting.	

Menu item	Description
Enable mDNS Off On*	Update multicast DNS settings.
WINS Address	Specify a server address for Windows Internet Name Service (WINS).
Enable BOOTP Off* On	Allow the BOOTP to assign a printer IP address.
Restricted Server List	Specify an IP address for the TCP connections. Notes: <ul style="list-style-type: none"> • Use a comma to separate each IP address. • You can add up to 50 IP addresses.
Restricted Server List Options Block All Ports* Block Printing Only Block Printing and HTTP Only	Specify how the IP addresses in the list can access the printer functionality.
MTU	Specify a maximum transmission unit (MTU) parameter for the TCP connections.
Raw Print Port 1–65535 (9100*)	Specify a raw port number for printers connected on a network.
Outbound Traffic Maximum Speed Off* 100 to 1000000	Enable the printer maximum transfer rate.
Enhanced TLS Security On Off*	Enhance printer privacy and data integrity.
Note: An asterisk (*) next to a value indicates the factory default setting.	

SNMP

Note: This menu appears only in network printers or printers that are attached to print servers.

Menu item	Description
<p>SNMP Versions 1 and 2c</p> <ul style="list-style-type: none"> Enabled Off On* Allow SNMP Set Off On* Enable PPM MIB Off On* SNMP Community 	<p>Configure Simple Network Management Protocol (SNMP) versions 1 and 2c to install print drivers and applications.</p>
<p>SNMP Version 3</p> <ul style="list-style-type: none"> Enabled Off On* Set Read/Write Credentials <ul style="list-style-type: none"> User Name Password Set Read-only Credentials <ul style="list-style-type: none"> User Name Password Authentication Hash <ul style="list-style-type: none"> MD5 SHA1* Minimum Authentication Level <ul style="list-style-type: none"> No Authentication, No Privacy Authentication, No Privacy Authentication, Privacy* Privacy Algorithm <ul style="list-style-type: none"> DES AES-128* 	<p>Configure SNMP version 3 to install and update printer security.</p>
<p>Note: An asterisk (*) next to a value indicates the factory default setting.</p>	

IPSec

Note: This menu appears only in network printers or printers that are attached to print servers.

Menu item	Description
<p>Enable IPSec</p> <ul style="list-style-type: none"> Off* On 	<p>Enable Internet Protocol Security (IPSec).</p>
<p>Note: An asterisk (*) next to a value indicates the factory default setting.</p>	

Menu item	Description
Base Configuration Default* Compatibility Secure	Set the IPSec base configuration. Note: This menu item appears only when Enable IPSec is set to On.
IPSec Device Certificate	Specify an IPSec certificate. Note: This menu item appears only when Base Configuration is set to Compatibility.
Pre-Shared Key Authenticated Connections Host [x] Address Key	Configure the authenticated connections of the printer. Note: These menu items appear only when Enable IPSec is set to On.
Certificate Authenticated Connections Host [x] Address[/subnet] Address[/subnet]	
Note: An asterisk (*) next to a value indicates the factory default setting.	

802.1x

Note: This menu appears only in network printers or printers that are attached to print servers.

Menu item	Description
Active Off* On	Let the printer join networks that require authentication before allowing access. Note: To configure the settings of this menu item, access the Embedded Web Server.
Note: An asterisk (*) next to a value indicates the factory default setting.	

LPD Configuration

Note: This menu appears only in network printers or printers that are attached to print servers.

Menu item	Description
LPD Timeout 0–65535 seconds (90*)	Set the time-out value to stop the Line Printer Daemon (LPD) server from waiting indefinitely for hung or invalid print jobs.
LPD Banner Page Off* On	Print a banner page for all LPD print jobs. Note: A banner page is the first page of a print job used as a separator of print jobs and to identify the originator of the print job request.
Note: An asterisk (*) next to a value indicates the factory default setting.	

Menu item	Description
LPD Trailer Page Off* On	Print a trailer page for all LPD print jobs. Note: A trailer page is the last page of a print job.
LPD Carriage Return Conversion Off* On	Enable carriage return conversion. Note: Carriage return is a mechanism that commands the printer to move the position of the cursor to the first position on the same line.
Note: An asterisk (*) next to a value indicates the factory default setting.	

HTTP/FTP Settings

Note: This menu appears only in network printers or printers attached to print servers.

Menu item	Description
Enable HTTP Server Off On*	Access the Embedded Web Server to monitor and manage the printer.
Enable HTTPS Off On*	Configure the Hypertext Transfer Protocol Secure (HTTPS) settings.
Enable FTP/TFTP Off On*	Send files using FTP.
Local Domains	Specify domain names for HTTP and FTP servers. Note: This menu item appears only in some printer models.
HTTP Proxy IP Address	Configure the HTTP and FTP server settings. Note: These menu items appear only in some printer models.
FTP Proxy IP Address	
HTTP Default IP Port 1–65535 (80*)	
HTTPS Device Certificate	
FTP Default IP Port 1–65535 (21*)	
Timeout for HTTP/FTP Requests 1–299 (30*)	Specify the amount of time before the server connection stops.
Retries for HTTP/FTP Requests 1–299 (3*)	Set the number of retries to connect to the HTTP/FTP server.
Note: An asterisk (*) next to a value indicates the factory default setting.	

ThinPrint

Menu item	Description
Enable ThinPrint Off On*	Print using ThinPrint.
Port Number 4000–4999 (4000*)	Set the port number for the ThinPrint server.
Bandwidth (bits/sec) 0* 100–1000000	Set the speed to transmit data in a ThinPrint environment.
Packet Size (kbytes) 0–64000 (0*)	Set the packet size for data transmission.
Note: An asterisk (*) next to a value indicates the factory default setting.	

USB

Menu item	Description
PCL SmartSwitch On* Off	Set the printer to switch to PCL emulation when a print job received through a USB port requires it, regardless of the default printer language. Note: If PCL SmartSwitch is off, then the printer does not examine incoming data and uses the default printer language specified in the Setup menu.
PS SmartSwitch On* Off	Set the printer to switch to PS emulation when a print job received through a USB port requires it, regardless of the default printer language. Note: If PS SmartSwitch is off, then the printer does not examine incoming data and uses the default printer language specified in the Setup menu.
Mac Binary PS Auto* On Off	Set the printer to process Macintosh binary PostScript print jobs. Notes: <ul style="list-style-type: none"> • On processes raw binary PostScript print jobs. • Off filters print jobs using the standard protocol.
Enable USB Port Enable* Disable	Enable the standard USB port.
Note: An asterisk (*) next to a value indicates the factory default setting.	

Google Cloud Print

Note: This feature is available only in some printer units.

Menu item	Description
Registration Register	Register the printer to the Google Cloud Print server.
Options Enable Google Cloud Print Off On*	Print directly from your Google account.
Options Enable Local Discovery Off On*	Allow the registered user and other users on the same subnet to send jobs to the printer locally.
Options Enable SSL Peer Verification Off On*	Verify authenticity of the peer certificate to connect to your Google account.
Options Always Print As Image Off* On	Set the printer to process PDF files as an image for faster printing.
Note: An asterisk (*) next to a value indicates the factory default setting.	

Wi-Fi Direct

Note: This menu appears only when a direct Wi-Fi network is the active network.

Menu item	Description
SSID	Specify the service set identifier (SSID) of the Wi-Fi network.
Set Preshared Key	Set the preshared key (PSK) to authenticate and validate users on a Wi-Fi connection.
Show PSK on Setup Page Off On*	Show the PSK on the Network Setup Page.
Group Owner IP Address	Specify the IP address of the group owner.
Auto-Accept Push Button Requests Off* On	Accept requests to connect to the network automatically. Note: Accepting clients automatically is not secured.
Note: An asterisk (*) next to a value indicates the factory default setting.	

USB Drive

Flash Drive Scan

Menu item	Description
Format PDF (.pdf)* TIFF (.tif) JPEG (.jpg) XPS (.xps)	Specify the file format for the scanned image. Note: The settings may vary depending on your printer model.
Global OCR Settings Recognized Languages Auto Rotate Despeckle Auto Contrast Enhance	Configure the settings for optical character recognition (OCR). Note: This menu appears only if you have purchased and installed an OCR solution.
PDF Settings PDF Version 1.3 1.4 1.5* 1.6 1.7 Archival Version A-1a* A-1b Secure Off* On Archival (PDF/A) Off* On	Set the PDF format for the scanned image.
Content Type Text Text/Photo* Graphics Photo	Improve the output result based on the content of the original document.
Note: An asterisk (*) next to a value indicates the factory default setting.	

Menu item	Description
Content Source Black and White Laser Color Laser* Inkjet Photo/Film Magazine Newspaper Press Other	Improve the output result based on the source of the original document.
Color Black and White Gray Color* Auto	Specify the color when scanning an image.
Resolution 75 dpi 150 dpi* 200 dpi 300 dpi 400 dpi 600 dpi	Set the resolution of the scanned image.
Darkness 1–9 (5*)	Adjust the darkness of the scanned image.
Orientation Portrait* Landscape	Specify the orientation of text and graphics on the page.
Original Size [List of paper sizes]	Set the paper size of the original document. Notes: <ul style="list-style-type: none"> • Letter is the U.S. factory default setting. A4 is the international factory default setting. • This menu item may vary depending on your printer model.
Sides Off* Long edge Short edge	Specify the page orientation of text and graphics when scanning a two-sided document.
File Name	Specify the file name of the scanned image.
Note: An asterisk (*) next to a value indicates the factory default setting.	

Advanced Imaging

Menu item	Description
Color Balance	Adjust the amount of toner used for each color.
Color Dropout Color Dropout None* Red Green Blue Default Red Threshold 0–255 (128*) Default Green Threshold 0–255 (128*) Default Blue Threshold 0–255 (128*)	Specify which color to drop during scanning, and adjust the dropout setting for that color.
Auto Color Detect Color Sensitivity 1–9 (5*) Area Sensitivity 1–9 (5*)	Set the amount of color that the printer detects from the original document. Note: This menu item appears only when Color is set to Auto.
JPEG Quality Best for content* 5–95	Set the quality of a JPEG-format image. Notes: <ul style="list-style-type: none"> • 5 reduces the file size, but lessens the image quality. • 90 provides the best image quality, but produces a large file size.
Contrast Best for content* 0 1 2 3 4 5	Specify the contrast of the output.
Background Removal Background Detection Content-based* Fixed Level -4 to 4 (0*)	Adjust the amount of background visible on a scanned image. Note: If you want to remove the background color from the original document, then set Background Detection to Content-based. If you want to remove image noise from a photo, then set Background Detection to Fixed.
Mirror Image Off* On	Create a mirror image of the original document.
Note: An asterisk (*) next to a value indicates the factory default setting.	

Menu item	Description
Negative Image Off* On	Create a negative image of the original document.
Shadow Detail -4 to 4 (0*)	Adjust the amount of shadow detail visible on a scanned image.
Scan Edge to Edge Off* On	Allow edge-to-edge scanning of the original document.
Sharpness 1–5 (3*)	Adjust the sharpness of a scanned image.
Temperature -4 to 4 (0*)	Specify whether to generate a cooler or warmer output.
Blank Pages Blank Page Removal Blank Page Sensitivity	Specify whether to include blank pages.
Note: An asterisk (*) next to a value indicates the factory default setting.	

Admin Controls

Menu item	Description
Text Default 5–95 (75*)	Set the quality of text on a scanned image.
Text/Photo Default 5–95 (75*)	Set the quality of text or photo on a scanned image.
Photo Default 5–95 (75*)	Set the quality of a photo on a scanned image.
Use Multi-Page TIFF On* Off	Choose between single- and multiple-page TIFF files.
TIFF Compression LZW* JPEG	Set the compression for TIFF files.
Scan Bit Depth 1 bit 8 bit*	Enable the Text/Photo mode to have smaller file sizes by using 1-bit image. Note: This menu item appears only when Color is set to Gray.
Custom Job Scanning Off* On	Turn on scanning of custom jobs by default. Note: This menu item appears only when a hard disk is installed.
Note: An asterisk (*) next to a value indicates the factory default setting.	

Menu item	Description
Scan Preview Off On*	Show a preview of the scan on the display. Note: This menu item appears only when a hard disk is installed.
Note: An asterisk (*) next to a value indicates the factory default setting.	

Flash Drive Print

Menu item	Description
Number of Copies 1–9999 (1*)	Set the number of copies.
Paper Source Tray [x] (1*) Multipurpose Feeder Manual Paper Manual Envelope	Set the paper source for the print job. Note: The multipurpose feeder is available only in some printer models.
Collate (1,1) (2,2,2) (1,2,3) (1,2,3)*	Print multiple copies in sequence.
Sides 1-Sided* 2-Sided	Specify whether to print on one side or two sides of the paper.
Flip Style Long Edge* Short Edge	Determine which side of the paper (long edge or short edge) is bound when performing two-sided printing. Note: Depending on the option selected, the printer automatically offsets each printed information of the page to bind the job correctly.
Pages per Side Off* 2 pages per side 3 pages per side 4 pages per side 6 pages per side 9 pages per side 12 pages per side 16 pages per side	Print multiple page images on one side of a sheet of paper.
Pages per Side Ordering Horizontal* Reverse Horizontal Reverse Vertical Vertical	Specify the positioning of multiple page images when using Pages per Side. Note: The positioning depends on the number of page images and their page orientation.
Note: An asterisk (*) next to a value indicates the factory default setting.	

Menu item	Description
Pages per Side Orientation Auto* Landscape Portrait	Specify the orientation of a multiple-page document when using Pages per Side.
Pages per Side Border None* Solid	Print a border around each page image when using Pages per Side.
Separator Sheets Off* Between Copies Between Jobs Between Pages	Specify whether to insert blank separator sheets when printing.
Separator Sheet Source Tray [x] (1*) Multipurpose Feeder	Specify the paper source for the separator sheet. Note: The multipurpose feeder is available only in some printer models.
Blank Pages Do Not Print* Print	Specify whether to print blank pages in a print job.
Note: An asterisk (*) next to a value indicates the factory default setting.	

Security

Login Methods

Manage Permissions

Menu item	Description
<p>Function Access</p> <ul style="list-style-type: none"> Access Address Book in Apps Modify Address Book Manage Shortcuts Create Profiles Manage Bookmarks Flash Drive Print Flash Drive Scan Copy Function Color Dropout E-mail Function Fax Function FTP Function Release Held Faxes Held Jobs Access User Profiles Cancel Jobs at the Device Change Language Internet Printing Protocol (IPP) Initiate Scans Remotely B/W Print 	<p>Control access to the printer functions.</p>
<p>Administrative Menus</p> <ul style="list-style-type: none"> Security Menu Network/Ports Menu Paper Menu Reports Menu Function Configuration Menus Supplies Menu Option Card Menu SE Menu Device Menu 	<p>Control access to the printer menu settings.</p>
<p>Device Management</p> <ul style="list-style-type: none"> Remote Management Firmware Updates Apps Configuration Operator Panel Lock Import/Export All Settings Out of Service Erase 	<p>Control access to the printer management options.</p>

Menu item	Description
<p>Apps</p> <ul style="list-style-type: none"> New Apps Slideshow Change Wallpaper Screen Saver Card Copy Scan Center Scan Center Custom 1 Scan Center Custom 2 Scan Center Custom 3 Scan Center Custom 4 Scan Center Custom 5 Scan Center Custom 6 Scan Center Custom 7 Scan Center Custom 8 Scan Center Custom 9 Scan Center Custom 10 Forms and Favorites 	<p>Control access to printer applications.</p>

Local Accounts

Menu item	Description
<p>Manage Groups/Permissions</p> <ul style="list-style-type: none"> Add Group <ul style="list-style-type: none"> Import Access Controls Function Access Administrative Menus Device Management Apps All Users <ul style="list-style-type: none"> Import Access Controls Function Access Administrative Menus Device Management Apps Admin 	<p>Control group or user access to the printer functions, applications, and security settings.</p>

Menu item	Description
Add User User Name/Password User Name Password PIN	Create local accounts to manage access to the printer functions.
User Name/Password Accounts Add User	
User Name Accounts Add User	
Password Accounts Add User	
PIN Accounts Add User	

Schedule USB Devices

Menu item	Description
Schedules Add New Schedule	Schedule access to the USB ports.

Security Audit Log

Menu item	Description
Enable Audit Off* On	Record the events in the secure audit log and remote syslog.
Enable Remote Syslog Off* On	Send audit logs to a remote server.
Remote Syslog Server	Specify the remote syslog server.
Remote Syslog Port 1–65535 (514*)	Specify the remote syslog port.
Remote Syslog Method Normal UDP* Stunnel	Specify a syslog method to transmit logged events to a remote server.
Note: An asterisk (*) next to a value indicates the factory default setting.	

Menu item	Description
<p>Remote Syslog Facility</p> <ul style="list-style-type: none"> 0 - Kernel Messages 1 - User-Level Messages 2 - Mail System 3 - System Daemons 4 - Security/Authorization Messages* 5 - Messages Generated Internally by Syslogs 6 - Line Printer Subsystem 7 - Network News Subsystem 8 - UUCP Subsystem 9 - Clock Daemon 10 - Security/Authorization Messages 11 - FTP Daemon 12 - NTP Subsystem 13 - Log Audit 14 - Log Alert 15 - Clock Daemon 16 - Local Use 0 (local0) 17 - Local Use 1 (local1) 18 - Local Use 2 (local2) 19 - Local Use 3 (local3) 20 - Local Use 4 (local4) 21 - Local Use 5 (local5) 22 - Local Use 6 (local6) 23 - Local Use 7 (local7) 	<p>Specify a facility code that the printer uses when sending log events to a remote server.</p>
<p>Severity of Events to Log</p> <ul style="list-style-type: none"> 0 - Emergency 1 - Alert 2 - Critical 3 - Error 4 - Warning* 5 - Notice 6 - Informational 7 - Debug 	<p>Specify the priority level cutoff for logging messages and events.</p>
<p>Remote Syslog Non-Logged Events</p> <ul style="list-style-type: none"> Off* On 	<p>Send all events, regardless of severity level, to the remote server.</p>
<p>Admin's E-mail Address</p>	<p>Send e-mail notification of logged events to the administrator.</p>
<p>Note: An asterisk (*) next to a value indicates the factory default setting.</p>	

Menu item	Description
E-mail Log Cleared Alert Off* On	Send e-mail notification to the administrator when a log entry is deleted.
E-mail Log Wrapped Alert Off* On	Send e-mail notification to the administrator when the log becomes full and begins to overwrite the oldest entries.
Log Full Behavior Wrap Over Older Entries* E-mail Log Then Delete All Entries	Resolve log storage issues when the log fills its allotted memory.
E-mail % Full Alert Off* On	Send e-mail notification to the administrator when the log fills its allotted memory.
% Full Alert Level 1–99 (90*)	
E-mail Log Exported Alert Off* On	Send e-mail notification to the administrator when a log is exported.
E-mail Log Settings Changed Alert Off* On	Send e-mail notification to the administrator when Enable Audit is set.
Log Line Endings LF (\n)* CR (\r) CRLF (\r\n)	Specify how the log file terminates the end of each line.
Digitally Sign Exports Off* On	Add a digital signature to each exported log file.
Clear Log	Delete all audit logs.
Export Log Syslog (RFC 5424) Syslog (RFC 3164) CSV	Export a security log to a flash drive.
Note: An asterisk (*) next to a value indicates the factory default setting.	

Login Restrictions

Menu item	Description
Login failures 1–10 (3*)	Specify the number of failed login attempts before the user gets locked out.
Failure time frame 1–60 minutes (5*)	Specify the time frame between failed login attempts before the user gets locked out.
Lockout time 1–60 minutes (5*)	Specify the lockout duration.
Web Login Timeout 1–120 minutes (10*)	Specify the delay for a remote login before the user is logged off automatically.
Note: An asterisk (*) next to a value indicates the factory default setting.	

Confidential Print Setup

Menu item	Description
Max Invalid PIN 2–10	Set the number of times an invalid PIN can be entered. Notes: <ul style="list-style-type: none"> • A value of zero turns off this setting. • When the limit is reached, the print jobs for that user name and PIN are deleted. • This menu item appears only when a hard disk is installed.
Confidential Job Expiration Off* 1 Hour 4 Hours 24 Hours 1 Week	Set the expiration time for confidential print jobs. Notes: <ul style="list-style-type: none"> • If this menu item is changed while confidential print jobs reside in the printer memory or hard disk, then the expiration time for those print jobs does not change to the new default value. • If the printer is turned off, then all confidential jobs held in the printer memory are deleted.
Repeat Job Expiration Off* 1 Hour 4 Hours 24 Hours 1 Week	Set the expiration time for a print job that you want to repeat.
Verify Job Expiration Off* 1 Hour 4 Hours 24 Hours 1 Week	Set the expiration time that the printer prints a copy for the user to examine its quality, before printing the remaining copies.
Note: An asterisk (*) next to a value indicates the factory default setting.	

Menu item	Description
Reserve Job Expiration Off* 1 Hour 4 Hours 24 Hours 1 Week	Set the expiration time that the printer stores print jobs for printing at a later time.
Require All Jobs to be Held Off* On	Set the printer to hold all print jobs.
Note: An asterisk (*) next to a value indicates the factory default setting.	

Disk Encryption

Note: This menu appears only when a printer hard disk is installed.

Menu item	Description
Status Enabled Disabled	Determine whether Disk Encryption is enabled.
Start encryption	Prevent the loss of sensitive data in case the printer or its hard disk is stolen. Note: Enabling disk encryption erases all contents in the hard disk. If necessary, back up important data from the printer before starting the encryption.

Erase Temporary Data Files

Menu item	Description
Stored in onboard memory Off* On	Delete all files stored on the printer memory.
Stored on hard disk 1 Pass Erase* 3 Pass Erase 7 Pass Erase	Delete all files stored on the printer hard disk.
Note: An asterisk (*) next to a value indicates the factory default setting.	

Solutions LDAP Settings

Use	To
Follow LDAP Referrals Off* On	Search the different servers in the domain for the logged-in user account.

Use	To
LDAP Certificate Verification No* Yes	Enable verification of LDAP certificates.

Mobile Services Management

Note: This feature is available only in some printer units.

Use	To
AirPrint Print Scan Fax	Enable functions in the AirPrint software feature.

Miscellaneous

Menu item	Description
Protected Features Show* Hide	Show all the features that Function Access Control (FAC) protects regardless of the security permission that the user has. Note: FAC manages access to specific menus and functions or disables them entirely.
Print Permission Off* On	Let the user log in before printing.
Default Print Permission Login	Set the default login for Print Permission.
Security Reset Jumper Enable "Guest" access* No Effect	Specify the effect of using the security reset jumper. Notes: <ul style="list-style-type: none"> • The jumper is located beside a lock icon on the controller board. • Enable "Guest" access provides full access control to users who are not logged in. • No Effect means that the reset has no effect on the printer security configuration.
Minimum Password Length 0–32 (0*)	Specify the minimum characters that are allowed for a password.

Note: An asterisk (*) next to a value indicates the factory default setting.

Reports

Menu Settings Page

Menu item	Description
Menu Settings Page	Print a report that contains the printer menus.

Device

Menu item	Description
Device Information	Print a report that contains information about the printer.
Device Statistics	Print a report about printer usage and supply status.
Profiles List	Print a list of profiles that are stored in the printer.

Print

Menu item	Description
Print Fonts PCL Fonts PS Fonts	Print samples and information about the fonts that are available in each printer language.
Print Directory	Print the resources that are stored in the flash drive or printer hard disk. Note: This menu item appears only when a flash drive or printer hard disk is installed.

Shortcuts

Menu item	Description
All Shortcuts	Print a report that lists the shortcuts that are stored in the printer.
Fax Shortcuts	
Copy Shortcuts	
E-mail Shortcuts	
FTP Shortcuts	
Network Folder Shortcuts	

Fax

Menu item	Description
Fax Job Log	Print a report about the last 200 completed fax jobs. Note: This menu item appears only when Enable Job Log is set to On.

Menu item	Description
Fax Call Log	Print a report about the last 100 attempted, received, and blocked calls. Note: This menu item appears only when Enable Job Log is set to On.

Network

Menu item	Description
Network Setup Page	Print a page that shows the configured network and wireless settings on the printer. Note: This menu item appears only in network printers or printers connected to print servers.

Help

Menu item	Description
Print All Guides	Prints all the guides
Connection Guide	Provides information about connecting the printer locally (USB) or to a network
Copy Guide	Provides information about making copies and configuring the settings
E-mail Guide	Provides information about sending e-mails and configuring the settings
Fax Guide	Provides information about sending faxes and configuring the settings
FTP Guide	Provides information about scanning documents and configuring the settings
Information Guide	Provides more information sources about the printer
Media Guide	Provides information about loading paper and specialty media
Mono Quality Guide	Provides information about mono print quality settings
Moving Guide	Provides information about moving, locating, or shipping the printer
Print Quality Guide	Provides information about solving print quality issues
Supplies Guide	Provides information about ordering supplies

Troubleshooting

Troubleshooting

Menu item	Description
Print Quality Test Pages	Print sample pages to identify and correct print quality defects.
Cleaning the Scanner	Print instructions on how to clean the scanner.

Printing the Menu Settings Page

From the home screen, touch **Settings > Reports > Menu Settings Page**.

Securing the printer

Locating the security slot

The printer is equipped with a security lock feature. Attach a security lock compatible with most laptop computers in the location shown to secure the printer in place.



Erasing printer memory

To erase volatile memory or buffered data in your printer, turn off the printer.

To erase non-volatile memory or individual settings, device and network settings, security settings, and embedded solutions, do the following:

- 1 From the home screen, touch **Settings > Device > Maintenance > Out of Service Erase**.
- 2 Select the **Sanitize all information on nonvolatile memory** check box, and then touch **ERASE**.
- 3 Follow the instructions on the display.

Erasing printer hard disk memory

- 1 From the home screen, touch **Settings > Device > Maintenance > Out of Service Erase**.
- 2 Select the **Sanitize all information on hard disk** check box, and then touch **ERASE**.
- 3 Follow the instructions on the display.

Note: This process can take from several minutes to more than an hour, making the printer unavailable for other tasks.

Encrypting the printer hard disk

This process erases all contents in the hard disk. If necessary, back up important data from the printer before starting the encryption.

- 1 From the home screen, touch **Settings** > **Security** > **Disk Encryption** > **Start encryption**.
- 2 Follow the instructions on the display.

Notes:

- To avoid loss of data, do not turn off the printer during the encryption process.
- This process can take from several minutes to more than an hour, making the printer unavailable for other tasks.
- After encryption, the printer automatically restarts.

Restoring factory default settings

From the home screen, touch **Settings** > **Device** > **Restore Factory Defaults** > **Restore Settings** > **Restore all settings** > **RESTORE** > **Start**.

For more information, see [“Erasing printer memory” on page 128](#).

Statement of Volatility

Type of memory	Description
Volatile memory	The printer uses standard random access memory (RAM) to buffer temporarily user data during simple print and copy jobs.
Non-volatile memory	The printer may use two forms of non-volatile memory: EEPROM and NAND (flash memory). Both types are used to store the operating system, printer settings, network information, scanner and bookmark settings, and embedded solutions.
Hard disk memory	Some printers may have a hard disk drive installed. The printer hard disk is designed for printer-specific functionality. The hard disk lets the printer retain buffered user data from complex print jobs, form data, and font data.

Erase the content of any installed printer memory in the following circumstances:

- The printer is decommissioned.
- The printer hard disk is replaced.
- The printer is moved to a different department or location.
- The printer is serviced by someone from outside your organization.
- The printer is removed from your premises for service.
- The printer is sold to another organization.

Disposing of a printer hard disk

- **Degaussing**—Flushes the hard disk with a magnetic field that erases stored data
- **Crushing**—Physically compresses the hard disk to break component parts and render them unreadable
- **Milling**—Physically shreds the hard disk into small metal bits

Note: To guarantee that all data are completely erased, destroy physically each hard disk where data is stored.

Maintaining the printer

Warning—Potential Damage: Failure to maintain optimum printer performance, or to replace parts and supplies, may cause damage to your printer.

Adjusting the speaker volume

Adjusting the default internal speaker volume

The speaker volume will reset to default value after the session is logged out, when the printer wakes from Sleep or Hibernate mode, or after a power-on reset.

- 1 From the control panel, navigate to:
Settings > Device > Preferences > Audio Feedback
- 2 Select the volume.

Note: If Quiet Mode is enabled, then audible alerts are turned off.

Configuring the fax speaker settings

Note: This feature is available only in some printer models.

- 1 From the control panel, navigate to:
Settings > Fax > Analog Fax Setup > Speaker Settings

For non-touch-screen printer models, press  to navigate through the settings.

- 2 Do the following:
 - Set the Speaker Mode to **Always On**.
 - Set the Speaker Volume to **High**.
 - Activate the Ringer Volume.

Networking

Connecting the printer to a Wi-Fi network

- 1 From the printer control panel, navigate to:
Settings > Network/Ports > Wireless

For non-touch-screen printer models, press  to navigate through the settings.

- 2 Select **Setup On Printer Panel** and then follow the instructions on the display.

Note: For Wi-Fi-network-ready printer models, a prompt for Wi-Fi network setup appears during initial setup.

Connecting the printer to a wireless network using Wi-Fi Protected Setup (WPS)

Before you begin, make sure that:

- The access point (wireless router) is WPS-certified or WPS-compatible. For more information, see the documentation that came with your access point.
- A wireless network adapter is installed in your printer. For more information, see the instructions that came with the adapter.

Using the Push Button method

- 1 From the control panel, navigate to:
Settings > Network/Ports > Wireless > Wi-Fi Protected Setup > Start Push Button Method
- 2 Follow the instructions on the display.

Using the personal identification number (PIN) method

- 1 From the control panel, navigate to:
Settings > Network/Ports > Wireless > Wi-Fi Protected Setup > Start PIN Method
- 2 Copy the eight-digit WPS PIN.
- 3 Open a Web browser, and then type the IP address of your access point in the address field.

Notes:

- View the printer IP address on the printer home screen. The IP address appears as four sets of numbers separated by periods, such as 123.123.123.123.
 - If you are using a proxy server, then temporarily disable it to load the Web page correctly.
- 4 Access the WPS settings. For more information, see the documentation that came with your access point.
 - 5 Enter the eight-digit PIN, and then save the changes.

Deactivating the Wi-Fi network

- 1 From the printer control panel, navigate to:
Settings > Network/Ports > Network Overview > Active Adapter > Standard Networking

For non-touch-screen printer models, press  to navigate through the settings.

- 2 Follow the instructions on the display.

Changing the printer port settings after installing an internal solutions port

Notes:

- If the printer has a static IP address, then do not change the configuration.
- If the computers are configured to use the network name instead of an IP address, then do not change the configuration.
- If you are adding a wireless internal solutions port (ISP) to a printer previously configured for an Ethernet connection, then disconnect the printer from the Ethernet network.

For Windows users

- 1 Open the printers folder.
- 2 From the shortcut menu of the printer with the new ISP, open the printer properties.
- 3 Configure the port from the list.
- 4 Update the IP address.
- 5 Apply the changes.

For Macintosh users

- 1 From System Preferences in the Apple menu, navigate to the list of printers, and then select + > **IP**.
- 2 Type the IP address in the address field.
- 3 Apply the changes.

Cleaning printer parts

Cleaning the printer

 **CAUTION—SHOCK HAZARD:** To avoid the risk of electrical shock when cleaning the exterior of the printer, unplug the power cord from the electrical outlet and disconnect all cables from the printer before proceeding.

Notes:

- Perform this task after every few months.
 - Damage to the printer caused by improper handling is not covered by the printer warranty.
- 1 Turn off the printer, and then unplug the power cord from the electrical outlet.
 - 2 Remove paper from the standard bin and multipurpose feeder.
 - 3 Remove any dust, lint, and pieces of paper around the printer using a soft brush or vacuum.
 - 4 Wipe the outside of the printer with a damp, soft, lint-free cloth.

Notes:

- Do not use household cleaners or detergents, as they may damage the finish of the printer.

- Make sure that all areas of the printer are dry after cleaning.

5 Connect the power cord to the electrical outlet, and then turn on the printer.

⚠ CAUTION—POTENTIAL INJURY: To avoid the risk of fire or electrical shock, connect the power cord to an appropriately rated and properly grounded electrical outlet that is near the product and easily accessible.

Cleaning the scanner

1 Open the scanner cover.



2 Using a damp, soft, lint-free cloth, wipe the following areas:

- ADF glass



- ADF glass pad



- Scanner glass



- Scanner glass pad



3 Close the scanner cover.

4 Open the ADF cover.

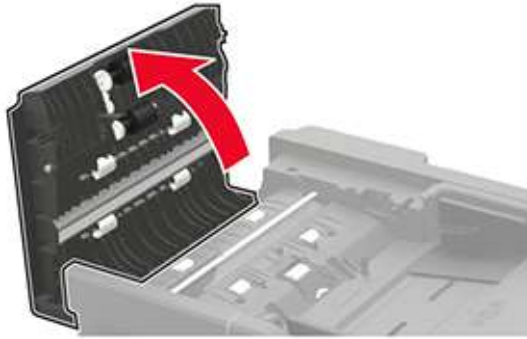

5 Using a damp, soft, lint-free cloth, wipe the following areas:

- ADF glass pad in the ADF cover

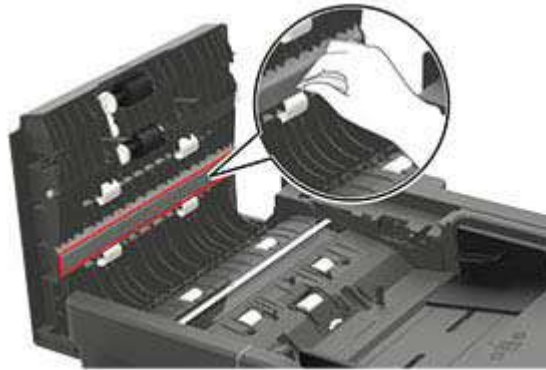

- ADF glass in the ADF cover

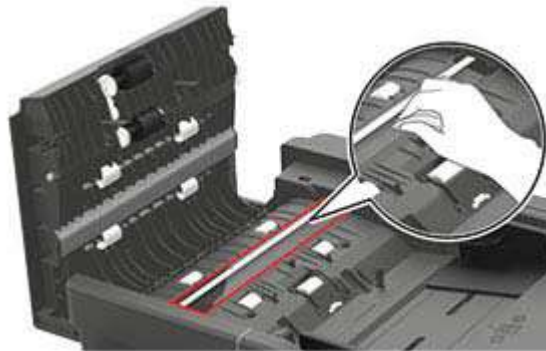

6 Close the ADF cover.

Ordering parts and supplies

Note: All life estimates for printer supplies assume printing on letter- or A4-size plain paper.

Checking the status of parts and supplies

- 1 From the home screen, touch **Status/Supplies**.
- 2 Select the parts or supplies that you want to check.

Note: You can also access this setting by touching the top section of the home screen.

Ordering a toner cartridge

Notes:

- The estimated cartridge yield is based on the ISO/IEC 19752 standard.
- Extremely low print coverage for extended periods of time may negatively affect actual yield.

To order a toner cartridge, contact the place where you purchased the printer.

Ordering an imaging unit

To order an imaging unit, contact the place where you purchased the printer.

Configuring supply notifications

- 1 Open a web browser, and then type the printer IP address in the address field.

Notes:

- View the printer IP address on the printer home screen. The IP address appears as four sets of numbers separated by periods, such as 123.123.123.123.
- If you are using a proxy server, then temporarily disable it to load the web page correctly.

- 2 Click **Settings > Device > Notifications**.
- 3 From the Supplies menu, click **Custom Supply Notifications**.
- 4 Select a notification for each supply item.
- 5 Apply the changes.

Replacing parts and supplies

Replacing the toner cartridge

- 1 Open door A.

Warning—Potential Damage: To prevent damage from electrostatic discharge, touch any exposed metal frame of the printer before accessing or touching interior areas of the printer.



2 Remove the used toner cartridge.



3 Unpack the new toner cartridge, and then shake it three times to redistribute the toner.



4 Insert the new toner cartridge.

Note: Use the arrows inside the printer as guides.



5 Close door A.

Replacing the imaging unit

1 Open door A.

Warning—Potential Damage: To prevent damage from electrostatic discharge, touch any exposed metal frame of the printer before accessing or touching interior areas of the printer.



- 2 Remove the toner cartridge.



- 3 Remove the used imaging unit.



- 4 Unpack the new imaging unit, and then shake it three times to redistribute the toner.



Warning—Potential Damage: Do not expose the imaging unit to direct light for more than 10 minutes. Extended exposure to light may cause print quality problems.

Warning—Potential Damage: Do not touch the photoconductor drum. Doing so may affect the quality of future print jobs.



5 Insert the new imaging unit.

Note: Use the arrows inside the printer as guides.



6 Insert the toner cartridge.

Note: Use the arrows inside the printer as guides.

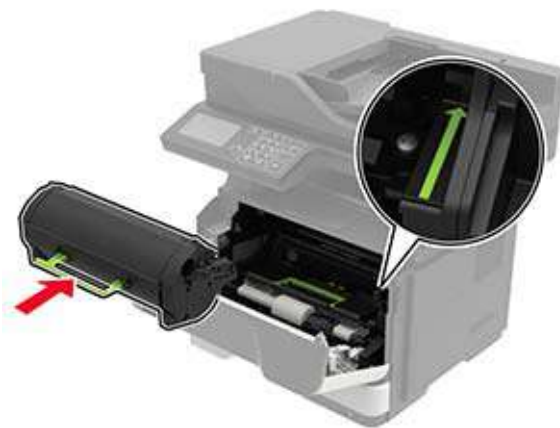

7 Close door A.

Replacing the pick tires

- 1 Turn off the printer.
- 2 Unplug the power cord from the electrical outlet, and then from the printer.
- 3 Remove the tray.

Warning—Potential Damage: To prevent damage from electrostatic discharge, touch any exposed metal frame of the printer before accessing or touching interior areas of the printer.



4 Remove the used pick tires one after the other.

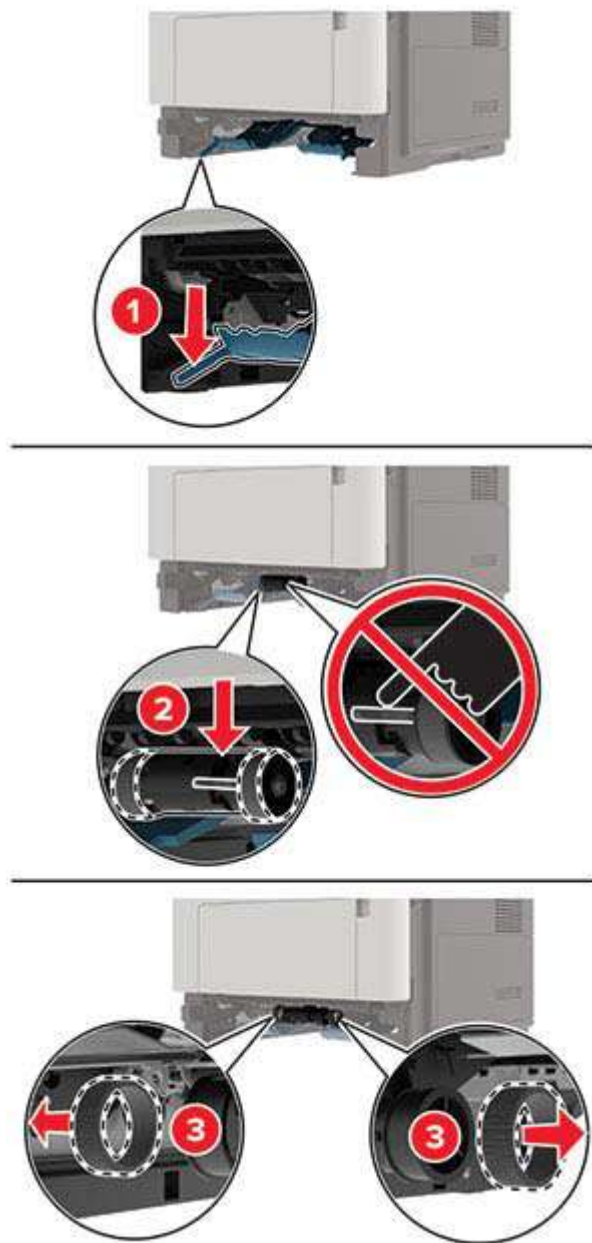

5 Unpack the new pick tires.

- 6 Insert the new pick tires.

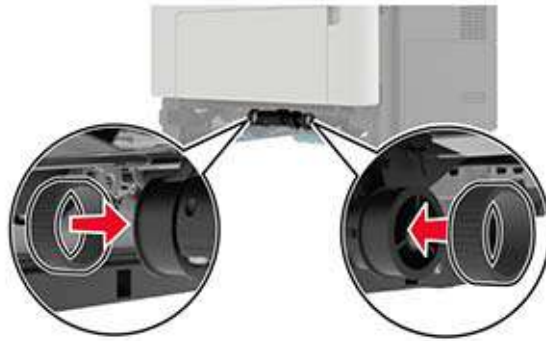

- 7 Insert the tray.
- 8 Connect the power cord to the printer, and then to the electrical outlet.

⚠ CAUTION—POTENTIAL INJURY: To avoid the risk of fire or electrical shock, connect the power cord to an appropriately rated and properly grounded electrical outlet that is near the product and easily accessible.

- 9 Turn on the printer.

Replacing the pick roller assembly

- 1 Turn off the printer.
- 2 Unplug the power cord from the electrical outlet, and then from the printer.
- 3 Remove the optional tray.

⚠ CAUTION—POTENTIAL INJURY: If the printer weight is greater than 18 kg (40 lb), then it requires two or more trained personnel to lift it safely.



- 4 Remove the tray insert, and then flip the tray base.

Warning—Potential Damage: To prevent damage from electrostatic discharge, touch any exposed metal frame of the printer before accessing or touching interior areas of the printer.

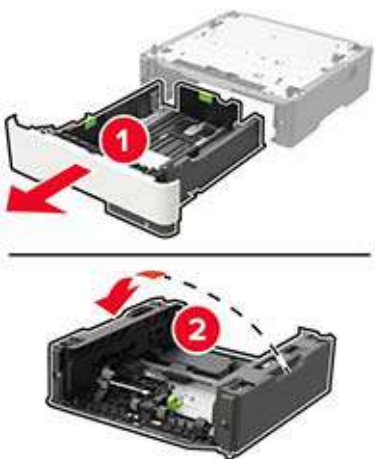

5 Remove the used pick roller assembly.

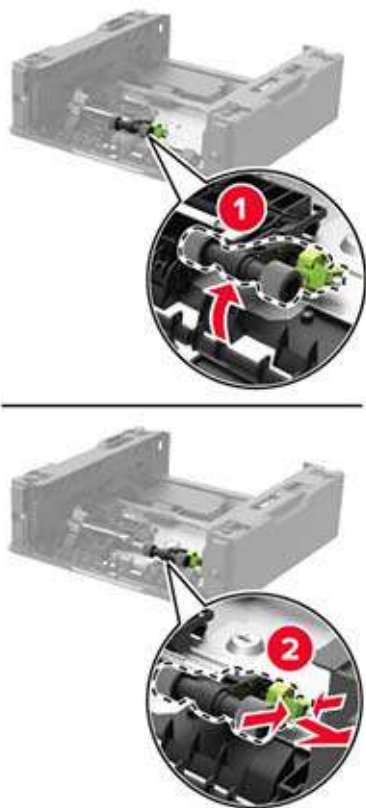

6 Unpack the new pick roller assembly.

7 Insert the new pick roller assembly.



8 Flip the tray base, and then insert the tray insert.

- 9 Align the printer with the optional tray, and then lower the printer until it *clicks* into place.



- 10 Connect the power cord to the printer, and then to the electrical outlet.

⚠ CAUTION—POTENTIAL INJURY: To avoid the risk of fire or electrical shock, connect the power cord to an appropriately rated and properly grounded electrical outlet that is near the product and easily accessible.

- 11 Turn on the printer.

Moving the printer

Moving the printer to another location

⚠ CAUTION—POTENTIAL INJURY: If the printer weight is greater than 18 kg (40 lb), then it requires two or more trained personnel to lift it safely.

⚠ CAUTION—POTENTIAL INJURY: To avoid the risk of fire or electrical shock, use only the power cord provided with this product or the manufacturer's authorized replacement.

⚠ CAUTION—POTENTIAL INJURY: When moving the printer, follow these guidelines to avoid personal injury or printer damage:

- Make sure that all doors and trays are closed.
- Turn off the printer, and then unplug the power cord from the electrical outlet.
- Disconnect all cords and cables from the printer.
- If the printer has separate floor-standing optional trays or output options attached to it, then disconnect them before moving the printer.
- If the printer has a caster base, then carefully roll it to the new location. Use caution when passing over thresholds and breaks in flooring.
- If the printer does not have a caster base but is configured with optional trays or output options, then remove the output options and lift the printer off the trays. Do not try to lift the printer and any options at the same time.

- Always use the handholds on the printer to lift it.
- Any cart used to move the printer must have a surface able to support the full footprint of the printer.
- Any cart used to move the hardware options must have a surface able to support the dimensions of the options.
- Keep the printer in an upright position.
- Avoid severe jarring movements.
- Make sure that your fingers are not under the printer when you set it down.
- Make sure that there is adequate clearance around the printer.

Note: Damage to the printer caused by improper moving is not covered by the printer warranty.

Shipping the printer

When shipping the printer, use the original packaging or contact the place where you purchased the printer.

Saving energy and paper

Configuring the power save mode settings

Eco-Mode

- 1 From the home screen, touch **Settings > Device > Power Management > Eco-Mode**.
- 2 Select a setting.

Sleep mode

- 1 From the home screen, touch **Settings > Device > Power Management > Timeouts > Sleep Mode**.
- 2 Specify the amount of time that the printer stays idle before it enters Sleep mode.

Hibernate mode

- 1 From the home screen, touch **Settings > Device > Power Management > Timeouts > Hibernate Timeout**.
- 2 Select the amount of time that the printer stays idle before it enters Hibernate mode.

Notes:

- For Hibernate Timeout to work, set Hibernate Timeout on Connection to Hibernate.
- The Embedded Web Server is disabled when the printer is in Hibernate mode.

Adjusting the brightness of the printer display

- 1 From the home screen, touch **Settings > Device > Preferences > Screen Brightness**.
- 2 Adjust the setting.

Conserving supplies

- Print on both sides of the paper.

Note: Two-sided printing is the default setting in the print driver.

- Print multiple pages on a single sheet of paper.
- Use the preview feature to see how the document looks like before printing it.
- Print one copy of the document to check its content and format for accuracy.

Clearing jams

Avoiding jams

Load paper properly

- Make sure that the paper lies flat in the tray.

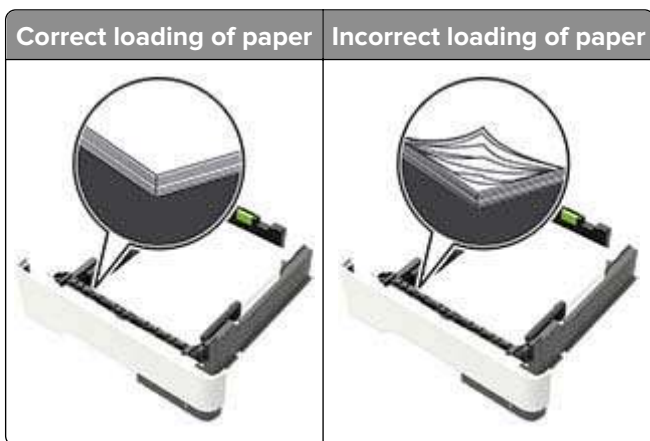

- Do not load or remove a tray while the printer is printing.
- Do not load too much paper. Make sure that the stack height is below the maximum paper fill indicator.
- Do not slide paper into the tray. Load paper as shown in the illustration.

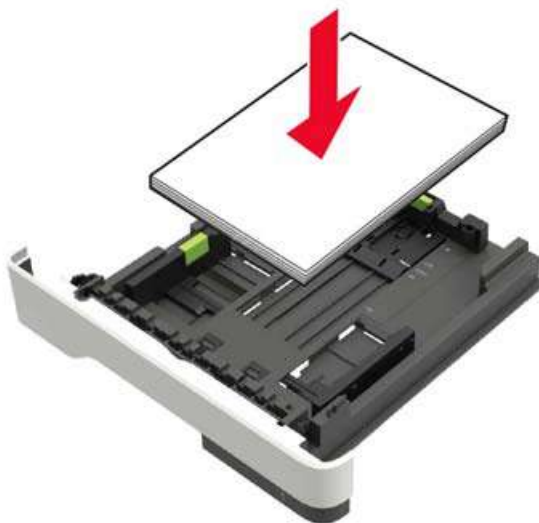

- Make sure that the paper guides are positioned correctly and are not pressing tightly against the paper or envelopes.
- Push the tray firmly into the printer after loading paper.

Use recommended paper

- Use only recommended paper or specialty media.
- Do not load paper that is wrinkled, creased, damp, bent, or curled.

- Flex, fan, and align the paper edges before loading.

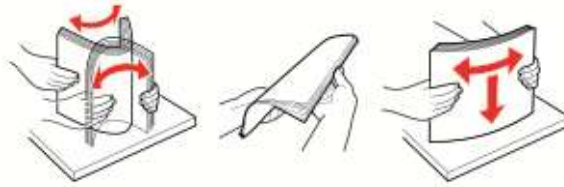

- Do not use paper that has been cut or trimmed by hand.
- Do not mix paper sizes, weights, or types in the same tray.
- Make sure that the paper size and type are set correctly on the computer or printer control panel.
- Store paper according to manufacturer recommendations.

Identifying jam locations

Notes:

- When Jam Assist is set to On, the printer automatically flushes blank pages or partially printed pages with after a jammed page is cleared. Check your printed output for blank pages.
- When Jam Recovery is set to On or Auto, the printer reprints jammed pages.

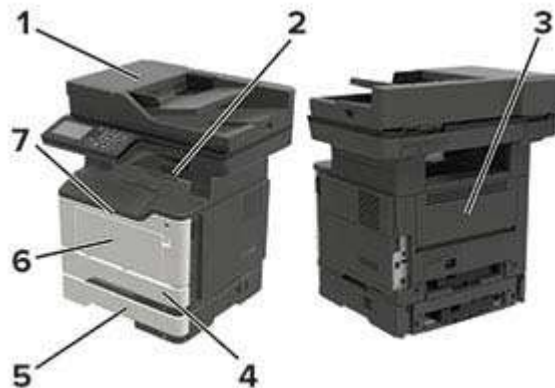

	Jam location
1	Automatic document feeder
2	Standard bin
3	Rear door
4	Standard 250-sheet tray
5	Optional 250- or 550-sheet tray
6	Multipurpose feeder
7	Door A

Paper jam in door A

- 1 Remove the tray.



- 2 Open door A.

Warning—Potential Damage: To prevent damage from electrostatic discharge, touch any exposed metal frame of the printer before accessing or touching interior areas of the printer.

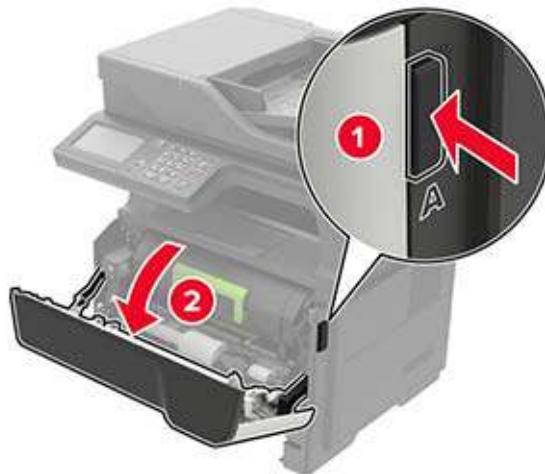

- 3 Remove the toner cartridge.



- 4 Remove the imaging unit.



Warning—Potential Damage: Do not expose the imaging unit to direct light for more than 10 minutes. Extended exposure to light may cause print quality problems.

Warning—Potential Damage: Do not touch the photoconductor drum. Doing so may affect the quality of future print jobs.



5 Remove the jammed paper.



CAUTION—HOT SURFACE: The inside of the printer might be hot. To reduce the risk of injury from a hot component, allow the surface to cool before touching it.

Note: Make sure that all paper fragments are removed.

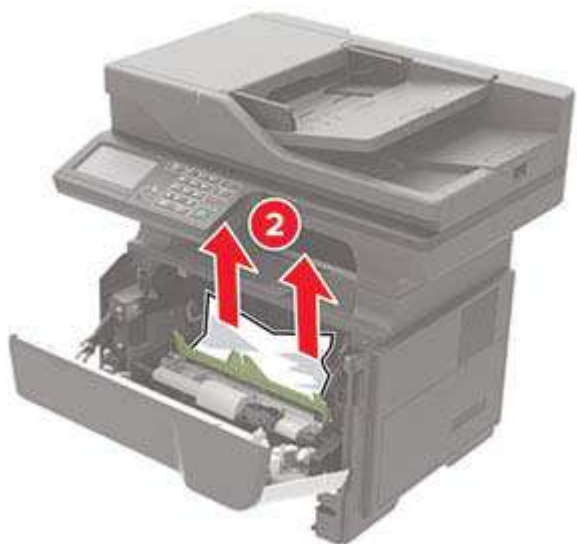

6 Insert the imaging unit.

Note: Use the arrows inside the printer as guides.



7 Insert the toner cartridge.

Note: Use the arrows inside the printer as guides.



8 Close the door.

9 Insert the tray.

Paper jam in the rear door

1 Open the rear door.

 **CAUTION—HOT SURFACE:** The inside of the printer might be hot. To reduce the risk of injury from a hot component, allow the surface to cool before touching it.

Warning—Potential Damage: To prevent damage from electrostatic discharge, touch any exposed metal frame of the printer before accessing or touching interior areas of the printer.



2 Remove the jammed paper.

Note: Make sure that all paper fragments are removed.



3 Close the rear door.

Paper jam in the standard bin

Remove the jammed paper.

Note: Make sure that all paper fragments are removed.



Paper jam in the duplex unit

- 1 Remove the tray.

Warning—Potential Damage: To prevent damage from electrostatic discharge, touch any exposed metal frame of the printer before accessing or touching interior areas of the printer.



- 2 Remove the jammed paper.

Note: Make sure that all paper fragments are removed.

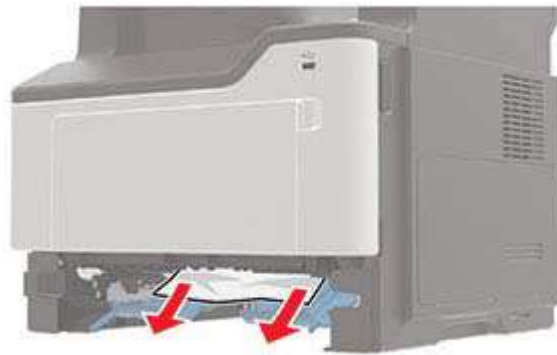

- 3 Insert the tray.

Paper jam in trays

- 1 Remove the tray.

Warning—Potential Damage: To prevent damage from electrostatic discharge, touch any exposed metal frame of the printer before accessing or touching interior areas of the printer.



- 2 Remove the jammed paper.

Note: Make sure that all paper fragments are removed.

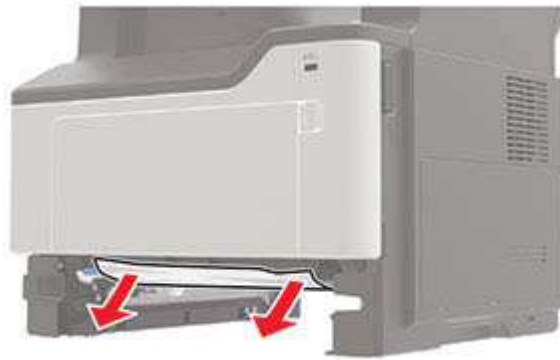

3 Insert the tray.

Paper jam in the multipurpose feeder

1 Remove paper from the multipurpose feeder.

2 Remove the jammed paper.

Note: Make sure that all paper fragments are removed.



3 Flex, fan, and align the paper edges before loading.

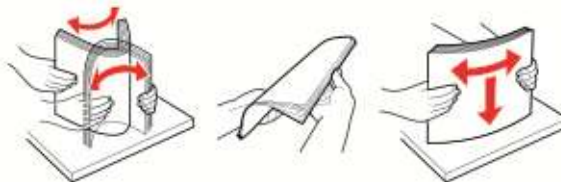

4 Reload paper, and then adjust the paper guide.



Paper jam in the automatic document feeder

- 1 Remove all original documents from the ADF tray.
- 2 Open the ADF cover.



- 3 Remove the jammed paper.
Note: Make sure that all paper fragments are removed.

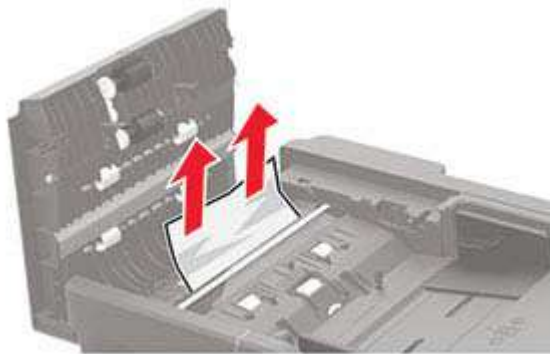

- 4 Close the ADF cover.

Troubleshooting

Network connection problems

Cannot open Embedded Web Server

Action	Yes	No
<p>Step 1</p> <p>Check if you are using a supported browser:</p> <ul style="list-style-type: none"> • Internet Explorer® version 9 or later • Safari version 8.0.3 or later • Google Chrome™ • Mozilla Firefox <p>Is your browser supported?</p>	Go to step 2.	Install a supported browser.
<p>Step 2</p> <p>Make sure that the printer IP address is correct.</p> <p>View the printer IP address:</p> <ul style="list-style-type: none"> • From the home screen • From the TCP/IP section in the Network/Ports menu • By printing a network setup page or menu settings page, and then finding the TCP/IP section <p>Note: An IP address appears as four sets of numbers separated by periods, such as 123.123.123.123.</p> <p>Is the printer IP address correct?</p>	Go to step 3.	Type the correct printer IP address in the address field.
<p>Step 3</p> <p>Check if the printer is on.</p> <p>Is the printer on?</p>	Go to step 4.	Turn on the printer.
<p>Step 4</p> <p>Check if the network connection is working.</p> <p>Is the network connection working?</p>	Go to step 5.	Contact your administrator.
<p>Step 5</p> <p>Make sure that the cable connections to the printer and print server are secure.</p> <p>For more information, see the setup documentation that came with the printer.</p> <p>Are the cable connections secure?</p>	Go to step 6.	Secure the cable connections.

Action	Yes	No
<p>Step 6 Check if the web proxy servers are disabled.</p> <p>Are the web proxy servers disabled?</p>	Go to step 7.	Contact your administrator.
<p>Step 7 Access the Embedded Web Server.</p> <p>Did the Embedded Web Server open?</p>	The problem is solved.	Contact customer support .

Unable to read flash drive

Action	Yes	No
<p>Step 1 Check if the flash drive is inserted into the front USB port.</p> <p>Note: The flash drive does not work when it is inserted into the rear USB port.</p> <p>Is the flash drive inserted into the correct port?</p>	Go to step 2.	Insert the flash drive into the correct port.
<p>Step 2 Check if the flash drive is supported. For more information, see “Supported flash drives and file types” on page 32.</p> <p>Is the flash drive supported?</p>	Go to step 3.	Insert a supported flash drive.
<p>Step 3</p> <p>a Check if the USB port is enabled. For more information, see “Enabling the USB port” on page 164.</p> <p>b Remove, and then insert the flash drive.</p> <p>Does the printer recognize the flash drive?</p>	The problem is solved.	Contact customer support .

Enabling the USB port

From the home screen, touch **Settings > Network/Ports > USB > Enable USB Port**.

Checking the printer connectivity

- 1 From the home screen, touch **Settings > Reports > Network > Network Setup Page**.
- 2 Check the first section of the network setup page, and confirm that the status is connected.
If the status is not connected, then the LAN drop may be inactive, or the network cable may be malfunctioning. Contact your administrator for assistance.

Internal option problems

Cannot detect internal option

Action	Yes	No
<p>Step 1 Turn off the printer, wait for about 10 seconds, and then turn it back on.</p> <p>Does the internal option operate correctly?</p>	The problem is solved.	Go to step 2.
<p>Step 2 Print a menu settings page, and then check if the internal option appears in the Installed Features list.</p> <p>Is the internal option listed in the menu settings page?</p>	Go to step 4.	Go to step 3.
<p>Step 3 Check if the internal option is properly installed in the controller board.</p> <ul style="list-style-type: none"> a Turn off the printer, and then unplug the power cord from the electrical outlet. b Make sure that the internal option is installed in the appropriate connector in the controller board. c Connect the power cord to the electrical outlet, and then turn on the printer. <p> CAUTION—POTENTIAL INJURY: To avoid the risk of fire or electrical shock, connect the power cord to an appropriately rated and properly grounded electrical outlet that is near the product and easily accessible.</p> <p>Does the internal option operate correctly?</p>	The problem is solved.	Go to step 4.
<p>Step 4</p> <ul style="list-style-type: none"> a Check if the internal option is available in the print driver. Note: If necessary, manually add the internal option in the print driver to make it available for print jobs. For more information, see “Adding available options in the print driver” on page 210. b Resend the print job. <p>Does the internal option operate correctly?</p>	The problem is solved.	Contact customer support .

Issues with supplies

Replace cartridge, printer region mismatch

Install the correct toner cartridge.

Non-Printer Manufacturer supply

The printer has detected an unrecognized supply or part installed in the printer.

Your printer is designed to function best with genuine supplies and parts made by the printer manufacturer. Use of third-party supplies or parts may affect the performance, reliability, or life of the printer and its imaging components.

All life indicators are designed to function with supplies and parts from the printer manufacturer and may deliver unpredictable results if third-party supplies or parts are used. Imaging component usage beyond the intended life may damage your printer or associated components.

Warning—Potential Damage: Use of third-party supplies or parts can affect warranty coverage. Damage caused by the use of third-party supplies or parts may not be covered by the warranty.

To accept any and all of these risks and to proceed with the use of non-genuine supplies or parts in your printer, from the control panel, press and hold **X** and **#** simultaneously for 15 seconds.

If you do not want to accept these risks, then remove the third-party supply or part from your printer and install a genuine supply or part from the printer manufacturer.

Scanner maintenance required, use ADF Kit

The printer is scheduled for maintenance. Contact customer support or your service representative, and then report the message.

Paper feed problems

Envelope seals when printing

Action	Yes	No
<p>1 Use envelopes that have been stored in a dry environment.</p> <p>Note: Printing on envelopes with high moisture content can seal the flaps.</p> <p>2 Resend the print job.</p> <p>Does the envelope seal when printing?</p>	<p>Contact customer support.</p>	<p>The problem is solved.</p>

Collated printing does not work

Action	Yes	No
<p>Step 1</p> <p>a From the home screen, touch Settings > Print > Layout > Collate.</p> <p>b Set Collate to On.</p> <p>c Print the document.</p> <p>Are the pages collated correctly?</p>	The problem is solved.	Go to step 2.
<p>Step 2</p> <p>a From the document that you are trying to print, open the Print dialog, and then select Collate.</p> <p>b Print the document.</p> <p>Are the pages collated correctly?</p>	The problem is solved.	Go to step 3.
<p>Step 3</p> <p>a Reduce the number of pages to print.</p> <p>b Print the document.</p> <p>Are the pages collated correctly?</p>	The problem is solved.	Contact customer support .

Tray linking does not work

Action	Yes	No
<p>Step 1</p> <p>a Check if the trays have the same paper size and type.</p> <p>b Check if the paper guides are positioned correctly.</p> <p>c Print the document.</p> <p>Do the trays link correctly?</p>	The problem is solved.	Go to step 2.
<p>Step 2</p> <p>a From the home screen, touch Settings > Paper > Tray Configuration > Paper Size/Type.</p> <p>b Set the paper size and type to match the paper loaded in the linked trays.</p> <p>c Print the document.</p> <p>Do the trays link correctly?</p>	The problem is solved.	Contact customer support .

Paper frequently jams

Action	Yes	No
<p>Step 1</p> <p>a Pull out the tray.</p> <p>b Check if the paper is loaded correctly.</p> <p>Notes:</p> <ul style="list-style-type: none"> • Make sure that the paper guides are positioned correctly. • Make sure that the stack height is below the maximum paper fill indicator. • Make sure to print on recommended paper size and type. <p>c Insert the tray.</p> <p>d Print the document.</p> <p>Do paper jams still occur frequently?</p>	Go to step 2.	The problem is solved.
<p>Step 2</p> <p>a From the Paper menu on the control panel, check if the printer is detecting the correct paper size.</p> <p>b Resend the print job.</p> <p>Do paper jams still occur frequently?</p>	Go to step 3.	The problem is solved.
<p>Step 3</p> <p>a Load paper from a fresh package.</p> <p>b Print the document.</p> <p>Do paper jams still occur frequently?</p>	Contact customer support .	The problem is solved.

Jammed pages are not reprinted

Action	Yes	No
<p>a From the home screen, touch Settings > Device > Notifications > Jam Content Recovery.</p> <p>b Select On or Auto.</p> <p>c Apply the changes.</p> <p>Are the jammed pages reprinted?</p>	The problem is solved.	Contact customer support .

Printing problems

Confidential and other held documents do not print

Action	Yes	No
<p>Step 1</p> <p>a From the control panel, check if the documents appear in the Held Jobs list.</p> <p>Note: If the documents are not listed, then print the documents using the Print and Hold options.</p> <p>b Print the documents.</p> <p>Are the documents printed?</p>	The problem is solved.	Go to step 2.
<p>Step 2</p> <p>The print job may contain a formatting error or invalid data.</p> <ul style="list-style-type: none"> • Delete the print job, and then send it again. • For PDF files, generate a new file, and then print the documents. <p>Are the documents printed?</p>	The problem is solved.	Go to step 3.
<p>Step 3</p> <p>If you are printing from the Internet, then the printer may be reading the multiple job titles as duplicates.</p> <p>For Windows users</p> <p>a Open the Printing Preferences dialog.</p> <p>b From the Print and Hold section, select Keep duplicate documents.</p> <p>c Enter a PIN.</p> <p>d Resend the print job.</p> <p>For Macintosh users</p> <p>a Save and name each job differently.</p> <p>b Send the job individually.</p> <p>Are the documents printed?</p>	The problem is solved.	Go to step 4.
<p>Step 4</p> <p>a Delete some held jobs to free up printer memory.</p> <p>b Resend the print job.</p> <p>Are the documents printed?</p>	The problem is solved.	Go to step 5.

Action	Yes	No
<p>Step 5</p> <p>a Add printer memory.</p> <p>b Resend the print job.</p> <p>Are the documents printed?</p>	The problem is solved.	Contact customer support .

Slow printing

Action	Yes	No
<p>Step 1</p> <p>a Make sure that the printer is not in Eco-Mode and Quiet Mode.</p> <p>b Print the document.</p> <p>Is the printer still printing slow?</p>	Go to step 2.	The problem is solved.
<p>Step 2</p> <p>a Depending on your operating system, specify the paper type from the Printing Preferences or Print dialog.</p> <p>Notes:</p> <ul style="list-style-type: none"> • Make sure that the setting matches the paper loaded in the tray. • You can also change the setting from the Paper menu on the printer control panel. <p>b Print the document.</p> <p>Is the printer still printing slow?</p>	Go to step 3.	The problem is solved.
<p>Step 3</p> <p>a Reduce the number of pages to print.</p> <p>b Print the document.</p> <p>Is the printer still printing slow?</p>	Go to step 4.	The problem is solved.
<p>Step 4</p> <p>a Connect the printer cable securely to the printer and the computer, print server, option, or other network device.</p> <p>b Print the document.</p> <p>Is the printer still printing slow?</p>	Go to step 5.	The problem is solved.
<p>Step 5</p> <p>a From the Quality menu on the control panel, set Print Resolution to 600 dpi.</p> <p>b Print the document.</p> <p>Is the printer still printing slow?</p>	Go to step 6.	The problem is solved.

Action	Yes	No
<p>Step 6</p> <p>a Make sure that the printer is not overheating.</p> <p>Notes:</p> <ul style="list-style-type: none"> • Allow the printer to cool down after a very long print job. • Observe the recommended ambient temperature for the printer. For more information, see “Selecting a location for the printer” on page 10. <p>b Print the document.</p> <p>Is the printer still printing slow?</p>	Go to step 7.	The problem is solved.
<p>Step 7</p> <p>a Add more printer memory.</p> <p>b Print the document.</p> <p>Is the printer still printing slow?</p>	Contact customer support .	The problem is solved.

Print jobs do not print

Action	Yes	No
<p>Step 1</p> <p>a From the document that you are trying to print, open the Print dialog, and then check if you selected the correct printer.</p> <p>b Print the document.</p> <p>Is the document printed?</p>	The problem is solved.	Go to step 2.
<p>Step 2</p> <p>a Check if the printer is on.</p> <p>b Resolve any error messages that appear on the display.</p> <p>c Print the document.</p> <p>Is the document printed?</p>	The problem is solved.	Go to step 3.
<p>Step 3</p> <p>a Check if the ports are working, and if the cables are securely connected to the computer and the printer.</p> <p>For more information, see the setup documentation that came with the printer.</p> <p>b Print the document.</p> <p>Is the document printed?</p>	The problem is solved.	Go to step 4.

Action	Yes	No
<p>Step 4</p> <p>a Turn off the printer, wait for about 10 seconds, and then turn it back on.</p> <p>b Print the document.</p> <p>Is the document printed?</p>	The problem is solved.	Go to step 5.
<p>Step 5</p> <p>a Remove, and then install the printer software.</p> <p>b Print the document.</p> <p>Is the document printed?</p>	The problem is solved.	Contact customer support .

Print quality is poor

Blank or white pages

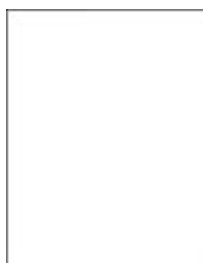

Note: Before solving the problem, print the Print Quality Test Pages. From the control panel, navigate to **Settings > Troubleshooting > Print Quality Test Pages**. For non-touch-screen printer models, press **OK** to navigate through the settings.

Action	Yes	No
<p>Step 1</p> <p>a Check if the printer is using a genuine and supported toner cartridge.</p> <p>Note: If the cartridge is not supported, then install a supported one.</p> <p>b Print the document.</p> <p>Is the printer printing blank or white pages?</p>	Go to step 2.	The problem is solved.

Action	Yes	No
<p>Step 2</p> <p>a Remove any packing material that is left on the imaging unit.</p> <p>1 Remove the toner cartridge, and then remove the imaging unit.</p> <p>Warning—Potential Damage: Do not expose the imaging unit to direct light for more than 10 minutes. Extended exposure to light may cause print quality problems.</p> <p>Warning—Potential Damage: Do not touch the photoconductor drum under the imaging unit. Doing so may affect the quality of future print jobs.</p> <p>2 Check the imaging unit for signs of damage, and replace if necessary.</p> <p>Note: Make sure that the photoconductor drum contact is not bent or out of place.</p> <p>3 Firmly shake the imaging unit to redistribute the toner.</p> <p>4 Insert the imaging unit, and then insert the toner cartridge.</p> <p>b Print the document.</p> <p>Is the printer printing blank or white pages?</p>	<p>Go to step 3.</p>	<p>The problem is solved.</p>
<p>Step 3</p> <p>Check the status of the toner cartridge, and replace if necessary.</p> <p>a From the control panel, navigate to:</p> <p>Status/Supplies > Supplies</p> <p>b Print the document.</p> <p>Is the printer printing blank or white pages?</p>	<p>Contact customer support.</p>	<p>The problem is solved.</p>

Dark print



Note: Before solving the problem, print the Print Quality Test Pages. From the control panel, navigate to **Settings > Troubleshooting > Print Quality Test Pages**. For non-touch-screen printer models, press  to navigate through the settings.

Action	Yes	No
<p>Step 1</p> <p>a Check if the printer is using a genuine and supported toner cartridge.</p> <p>Note: If the cartridge is not supported, then install a supported one.</p> <p>b Print the document.</p> <p>Is the print dark?</p>	Go to step 2.	The problem is solved.
<p>Step 2</p> <p>a Turn off the printer, wait for about 10 seconds, and then turn on the printer.</p> <p>b Reduce toner darkness. From the control panel, navigate to: Settings > Print > Quality</p> <p>c Print the document.</p> <p>Is the print dark?</p>	Go to step 3.	The problem is solved.
<p>Step 3</p> <p>a Depending on your operating system, specify the paper type from the Printing Preferences or Print dialog.</p> <p>Notes:</p> <ul style="list-style-type: none"> • Make sure that the setting matches the paper loaded. • You can also change the setting on the printer control panel. <p>b Print the document.</p> <p>Is the print dark?</p>	Go to step 4.	The problem is solved.
<p>Step 4</p> <p>Check if the paper has texture or rough finishes.</p> <p>Are you printing on textured or rough paper?</p>	Go to step 5.	Go to step 6.
<p>Step 5</p> <p>a Replace textured paper with plain paper.</p> <p>b Print the document.</p> <p>Is the print dark?</p>	Go to step 6.	The problem is solved.
<p>Step 6</p> <p>a Load paper from a fresh package.</p> <p>Note: Paper absorbs moisture due to high humidity. Store paper in its original wrapper until you are ready to use it.</p> <p>b Print the document.</p> <p>Is the print dark?</p>	Go to step 7.	The problem is solved.

Action	Yes	No
<p>Step 7</p> <p>a Remove, and then insert the imaging unit.</p> <p>Warning—Potential Damage: Do not expose the imaging unit to direct light for more than 10 minutes. Extended exposure to light may cause print quality problems.</p> <p>Warning—Potential Damage: Do not touch the photoconductor drum under the imaging unit. Doing so may affect the quality of future print jobs.</p> <p>b Print the document.</p> <p>Is the print dark?</p>	Go to step 8.	The problem is solved.
<p>Step 8</p> <p>a Replace the imaging unit.</p> <p>b Print the document.</p> <p>Is the print dark?</p>	Contact customer support .	The problem is solved.

Fine lines are not printed correctly



Note: Before solving the problem, print the Print Quality Test Pages. From the control panel, navigate to **Settings > Troubleshooting > Print Quality Test Pages**. For non-touch-screen printer models, press  to navigate through the settings.

Action	Yes	No
<p>Step 1</p> <p>a Check if the printer is using a genuine and supported toner cartridge.</p> <p>Note: If the cartridge is not supported, then install a supported one.</p> <p>b Print the document.</p> <p>Are fine lines not printed correctly?</p>	Go to step 2.	The problem is solved.

Action	Yes	No
<p>Step 2</p> <p>a Adjust the print quality settings.</p> <p> 1 From the control panel, navigate to: Settings > Print > Quality > Pixel Boost > Fonts</p> <p> 2 Adjust Toner Darkness to 7. From the control panel, navigate to: Settings > Print > Quality</p> <p>b Print the document.</p> <p>Are fine lines not printed correctly?</p>	<p>Contact customer support.</p>	<p>The problem is solved.</p>

Folded or wrinkled paper



Note: Before solving the problem, print the Print Quality Test Pages. From the control panel, navigate to **Settings > Troubleshooting > Print Quality Test Pages**. For non-touch-screen printer models, press  to navigate through the settings.

Action	Yes	No
<p>Step 1</p> <p>a Check if the printer is using a genuine and supported toner cartridge.</p> <p> Note: If the cartridge is not supported, then install a supported one.</p> <p>b Print the document.</p> <p>Is the paper folded or wrinkled?</p>	<p>Go to step 2.</p>	<p>The problem is solved.</p>
<p>Step 2</p> <p>a Load paper from a fresh package.</p> <p> Note: Paper absorbs moisture due to high humidity. Store paper in its original wrapper until you are ready to use it.</p> <p>b Print the document.</p> <p>Is the paper folded or wrinkled?</p>	<p>Go to step 3.</p>	<p>The problem is solved.</p>

Action	Yes	No
<p>Step 3</p> <p>a Depending on your operating system, specify the paper type from the Printing Preferences or Print dialog.</p> <p>Notes:</p> <ul style="list-style-type: none"> • Make sure that the setting matches the paper loaded. • You can also change the setting from the printer control panel. <p>b Print the document.</p> <p>Is the paper folded or wrinkled?</p>	<p>Contact customer support.</p>	<p>The problem is solved.</p>

Gray background

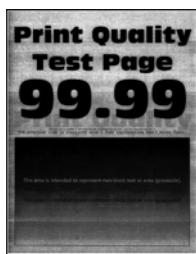

Note: Before solving the problem, print the Print Quality Test Pages. From the control panel, navigate to **Settings > Troubleshooting > Print Quality Test Pages**. For non-touch-screen printer models, press **OK** to navigate through the settings.

Action	Yes	No
<p>Step 1</p> <p>a Turn off the printer, wait for 10 seconds, and then turn on the printer.</p> <p>b Increase toner darkness. From the control panel, navigate to: Settings > Print > Quality</p> <p>c Print the document.</p> <p>Does gray background appear on prints?</p>	<p>Go to step 2.</p>	<p>The problem is solved.</p>
<p>Step 2</p> <p>a Check if the printer is using a genuine and supported toner cartridge. Note: If the toner cartridge is not supported, then install a supported one.</p> <p>b Print the document.</p> <p>Does gray background appear on prints?</p>	<p>Go to step 3.</p>	<p>The problem is solved.</p>

Action	Yes	No
<p>Step 3</p> <p>a Depending on your operating system, specify the paper type from the Printing Preferences or Print dialog.</p> <p>Notes:</p> <ul style="list-style-type: none"> • Make sure that the setting matches the paper loaded. • You can also change the setting from the printer control panel. <p>b Print the document.</p> <p>Does gray background appear on prints?</p>	<p>Go to step 4.</p>	<p>The problem is solved.</p>
<p>Step 4</p> <p>Check the status of the toner cartridge, and replace if necessary.</p> <p>a From the control panel, navigate to: Status/Supplies > Supplies</p> <p>b Print the document.</p> <p>Does gray background appear on prints?</p>	<p>Go to step 5.</p>	<p>The problem is solved.</p>
<p>Step 5</p> <p>a Remove the imaging unit.</p> <p>Warning—Potential Damage: Do not expose the imaging unit to direct light for more than 10 minutes. Extended exposure to light may cause print quality problems.</p> <p>Warning—Potential Damage: Do not touch the photoconductor drum under the imaging unit. Doing so may affect the quality of future print jobs.</p> <p>b Remove any packing material that is stuck on the imaging unit.</p> <div style="text-align: center;">  </div> <p>Note: Make sure to remove any obstruction between the charge roller and photoconductor drum.</p> <p>c Insert the imaging unit.</p> <p>d Print the document.</p> <p>Does gray background appear on prints?</p>	<p>Go to step 6.</p>	<p>The problem is solved.</p>
<p>Step 6</p> <p>a Replace the imaging unit.</p> <p>b Print the document.</p> <p>Does gray background appear on prints?</p>	<p>Contact customer support.</p>	<p>The problem is solved.</p>

Horizontal light bands



Note: Before solving the problem, print the Print Quality Test Pages. From the control panel, navigate to **Settings > Troubleshooting > Print Quality Test Pages**. For non-touch-screen printer models, press **OK** to navigate through the settings.

Action	Yes	No
<p>a Check if the printer is using a genuine and supported toner cartridge.</p> <p>Note: If the cartridge is not supported, then install a supported one.</p> <p>b Print the document.</p> <p>Do horizontal light bands appear on prints?</p>	<p>Contact customer support.</p>	<p>The problem is solved.</p>

Incorrect margins



Action	Yes	No
<p>Step 1</p> <p>a Adjust the paper guides to the correct position for the paper loaded.</p> <p>b Print the document.</p> <p>Are the margins correct?</p>	<p>The problem is solved.</p>	<p>Go to step 2.</p>

Action	Yes	No
<p>Step 2</p> <p>a Depending on your operating system, specify the paper size from the Printing Preferences or Print dialog.</p> <p>Notes:</p> <ul style="list-style-type: none"> • Make sure that the setting matches the paper loaded. • You can also change the setting from the printer control panel. <p>b Print the document.</p> <p>Are the margins correct?</p>	<p>The problem is solved.</p>	<p>Contact customer support.</p>

Light print



Note: Before solving the problem, print the Print Quality Test Pages. From the control panel, navigate to **Settings > Troubleshooting > Print Quality Test Pages**. For non-touch-screen printer models, press  to navigate through the settings.

Action	Yes	No
<p>Step 1</p> <p>a Check if the printer is using a genuine and supported toner cartridge.</p> <p>Note: If the cartridge is not supported, then install a supported one.</p> <p>b Print the document.</p> <p>Is the print light?</p>	<p>Go to step 2.</p>	<p>The problem is solved.</p>
<p>Step 2</p> <p>a Turn off the printer, wait for about 10 seconds, and then turn on the printer.</p> <p>b Increase toner darkness. From the control panel, navigate to: Settings > Print > Quality</p> <p>c Print the document.</p> <p>Is the print light?</p>	<p>Go to step 3.</p>	<p>The problem is solved.</p>

Action	Yes	No
<p>Step 3</p> <p>a Depending on your operating system, specify the paper type from the Printing Preferences or Print dialog.</p> <p>Notes:</p> <ul style="list-style-type: none"> • Make sure that the setting matches the paper loaded. • You can also change the setting on the printer control panel. <p>b Print the document.</p> <p>Is the print light?</p>	<p>Go to step 4.</p>	<p>The problem is solved.</p>
<p>Step 4</p> <p>Check the status of the toner cartridge, and replace if necessary.</p> <p>a From the control panel, navigate to: Status/Supplies > Supplies</p> <p>b Print the document.</p> <p>Is the print light?</p>	<p>Go to step 5.</p>	<p>The problem is solved.</p>
<p>Step 5</p> <p>a Remove the toner cartridge, and then remove the imaging unit.</p> <p>Warning—Potential Damage: Do not expose the imaging unit to direct light for more than 10 minutes. Extended exposure to light can cause print quality problems.</p> <p>Warning—Potential Damage: Do not touch the photoconductor drum under the imaging unit. Doing so may affect the quality of future print jobs.</p> <p>b Push either side of the transfer roller, located below the imaging unit, to check if it depresses and bounces back into place.</p> <p> CAUTION—HOT SURFACE: The inside of the printer might be hot. To reduce the risk of injury from a hot component, allow the surface to cool before touching it.</p> <p>c If the transfer roller does not depress and bounce back into place, then remove and insert it.</p> <ol style="list-style-type: none"> 1 Pull up one end of the transfer roller and push it down until it <i>clicks</i> into place. 2 If necessary, repeat the step on the other end. <p>d Firmly shake the imaging unit to redistribute the toner, and then insert it.</p> <p>e Insert the toner cartridge.</p> <p>f Turn off the printer, wait for 10 seconds, and then turn on the printer.</p> <p>g Print the document.</p> <p>Is the print light?</p>	<p>Go to step 6.</p>	<p>The problem is solved.</p>

Action	Yes	No
<p>Step 6</p> <p>a If the issue happens after installing a new maintenance kit, then check whether the transfer roller included with the kit is installed.</p> <p>Note: If necessary, replace the transfer roller.</p> <p>b Print the document.</p> <p>Is the print light?</p>	Go to step 7.	The problem is solved.
<p>Step 7</p> <p>Check the status of the imaging unit. From the control panel, navigate to:</p> <p>Status/Supplies > Supplies</p> <p>Is the imaging unit near End of Life?</p>	Go to step 8.	Contact customer support .
<p>Step 8</p> <p>a Replace the imaging unit.</p> <p>b Print the document.</p> <p>Is the print light?</p>	Contact customer support .	The problem is solved.

Mottled print and dots



Note: Before solving the problem, print the Print Quality Test Pages. From the control panel, navigate to **Settings > Troubleshooting > Print Quality Test Pages**. For non-touch-screen printer models, press  to navigate through the settings.

Action	Yes	No
<p>Step 1</p> <p>a Check if the printer is using a genuine and supported toner cartridge.</p> <p>Note: If the toner cartridge is not supported, then install a supported one.</p> <p>b Print the document.</p> <p>Is the print mottled?</p>	Go to step 2.	The problem is solved.

Action	Yes	No
<p>Step 2 Check the printer for leaked toner contamination.</p> <p>Is the printer free of leaked toner?</p>	Go to step 4.	Go to step 3.
<p>Step 3 a Replace the toner cartridge. b Print the document.</p> <p>Is the print mottled?</p>	Go to step 4.	The problem is solved.
<p>Step 4 Check the status of the imaging unit. From the control panel, navigate to: Status/Supplies > Supplies</p> <p>Is the imaging unit near end of life?</p>	Go to step 5.	Contact customer support .
<p>Step 5 a Replace the imaging unit. b Print the document.</p> <p>Is the print mottled?</p>	Contact customer support .	The problem is solved.

Paper curl



Note: Before solving the problem, print the Print Quality Test Pages. From the control panel, navigate to **Settings > Troubleshooting > Print Quality Test Pages**. For non-touch-screen printer models, press  to navigate through the settings.

Action	Yes	No
<p>Step 1 a Check if the printer is using a genuine and supported toner cartridge. Note: If the cartridge is not supported, then install a supported one. b Print the document.</p> <p>Is the paper curled?</p>	Go to step 2.	The problem is solved.

Action	Yes	No
<p>Step 2</p> <p>a Adjust the guides in the tray to the correct position for the paper loaded.</p> <p>b Print the document.</p> <p>Is the paper curled?</p>	Go to step 3.	The problem is solved.
<p>Step 3</p> <p>a Depending on your operating system, specify the paper size and paper type from the Printing Preferences or Print dialog.</p> <p>Notes:</p> <ul style="list-style-type: none"> • Make sure that the settings match the paper loaded. • You can also change the settings from the printer control panel. <p>b Print the document.</p> <p>Is the paper curled?</p>	Go to step 4.	The problem is solved.
<p>Step 4</p> <p>a Remove paper from the tray, and then turn over the paper.</p> <p>b Print the document.</p> <p>Is the paper curled?</p>	Go to step 5.	The problem is solved.
<p>Step 5</p> <p>a Load paper from a fresh package.</p> <p>Note: Paper absorbs moisture due to high humidity. Store paper in its original wrapper until you are ready to use it.</p> <p>b Print the document.</p> <p>Is the paper curled?</p>	Go to step 6.	The problem is solved.
<p>Step 6</p> <p>a Check if the paper loaded is supported.</p> <p>Note: If paper is not supported, then load a supported paper.</p> <p>b Print the document.</p> <p>Is the paper curled?</p>	Contact customer support .	The problem is solved.

Print crooked or skewed



Note: Before solving the problem, print the Print Quality Test Pages. From the control panel, navigate to **Settings > Troubleshooting > Print Quality Test Pages**. For non-touch-screen printer models, press **OK** to navigate through the settings.

Action	Yes	No
<p>Step 1</p> <p>a Adjust the guides in the tray to the correct position for the paper loaded.</p> <p>b Print the document.</p> <p>Is the print crooked or skewed?</p>	Go to step 2.	The problem is solved.
<p>Step 2</p> <p>a Check if the paper loaded is supported.</p> <p>Note: If paper is not supported, then load a supported paper.</p> <p>b Print the document.</p> <p>Is the print crooked or skewed?</p>	Go to step 3.	The problem is solved.
<p>Step 3</p> <p>a Check the pick tire in the tray for signs of damage and contamination, and replace if necessary.</p> <p>b Print the document.</p> <p>Is the print crooked or skewed?</p>	Contact customer support .	The problem is solved.

Repeating defects



Note: Before solving the problem, print the Print Quality Test Pages. From the control panel, navigate to **Settings > Troubleshooting > Print Quality Test Pages**. For non-touch-screen printer models, press **OK** to navigate through the settings.

Action	Yes	No
<p>Step 1</p> <p>Using the Print Quality Test Pages, check if the distance between the repeating defects is equal to any of the following:</p> <ul style="list-style-type: none"> • 97 mm (3.82 in.) • 47 mm (1.85 in.) • 38 mm (1.5 in.) <p>Does the distance between the repeating defects match any of the measurements?</p>	Go to step 2.	Take note of the distance, and then contact customer support .
<p>Step 2</p> <p>a Replace the imaging unit.</p> <p>b Print the document.</p> <p>Do the repeating defects appear?</p>	Contact customer support .	The problem is solved.

Solid black pages



Note: Before solving the problem, print the Print Quality Test Pages. From the control panel, navigate to **Settings > Troubleshooting > Print Quality Test Pages**. For non-touch-screen printer models, press **OK** to navigate through the settings.

Action	Yes	No
<p>Step 1</p> <p>a Check if the printer is using a genuine and supported toner cartridge.</p> <p>Note: If the toner cartridge is not supported, then install a supported one.</p> <p>b Print the document.</p> <p>Is the printer printing solid black pages?</p>	Go to step 2.	The problem is solved.

Action	Yes	No
<p>Step 2</p> <p>a Remove, and then insert the imaging unit.</p> <p>Warning—Potential Damage: Do not expose the imaging unit to direct light for more than 10 minutes. Extended exposure to light may cause print quality problems.</p> <p>Warning—Potential Damage: Do not touch the photoconductor drum under the imaging unit. Doing so may affect the quality of future print jobs.</p> <p>b Print the document.</p> <p>Is the printer printing solid black pages?</p>	<p>Go to step 3.</p>	<p>The problem is solved.</p>
<p>Step 3</p> <p>a Remove the imaging unit.</p> <p>Warning—Potential Damage: Do not expose the imaging unit to direct light for more than 10 minutes. Extended exposure to light may cause print quality problems.</p> <p>Warning—Potential Damage: Do not touch the photoconductor drum under the imaging unit. Doing so may affect the quality of future print jobs.</p> <p>b Remove any packing material that is stuck on the imaging unit.</p> <div data-bbox="396 1058 786 1201" data-label="Image"> </div> <p>Note: Make sure to remove any obstruction between the charge roller and photoconductor drum.</p> <p>c Insert the imaging unit.</p> <p>d Print the document.</p> <p>Is the printer printing solid black pages?</p>	<p>Go to step 4.</p>	<p>The problem is solved.</p>
<p>Step 4</p> <p>Check the imaging unit for signs of damage.</p> <p>Is the imaging unit free from damage?</p>	<p>Contact customer support.</p>	<p>Go to step 5.</p>
<p>Step 5</p> <p>a Replace the imaging unit.</p> <p>b Print the document.</p> <p>Is the printer printing solid black pages?</p>	<p>Contact customer support.</p>	<p>The problem is solved.</p>

Text or images cut off



Note: Before solving the problem, print the Print Quality Test Pages. From the control panel, navigate to **Settings > Troubleshooting > Print Quality Test Pages**. For non-touch-screen printer models, press **OK** to navigate through the settings.

Action	Yes	No
<p>Step 1</p> <p>a Check if the printer is using a genuine and supported toner cartridge.</p> <p>Note: If the toner cartridge is not supported, then install a supported one.</p> <p>b Print the document.</p> <p>Are text or images cut off?</p>	Go to step 2.	The problem is solved.
<p>Step 2</p> <p>a Remove, and then insert the imaging unit.</p> <p>Warning—Potential Damage: Do not expose the imaging unit to direct light for more than 10 minutes. Extended exposure to light may cause print quality problems.</p> <p>Warning—Potential Damage: Do not touch the photoconductor drum under the imaging unit. Doing so may affect the quality of future print jobs.</p> <p>b Print the document.</p> <p>Are text or images cut off?</p>	Go to step 3.	The problem is solved.

Action	Yes	No
<p>Step 3</p> <p>a Remove the imaging unit.</p> <p>Warning—Potential Damage: Do not expose the imaging unit to direct light for more than 10 minutes. Extended exposure to light may cause print quality problems.</p> <p>Warning—Potential Damage: Do not touch the photoconductor drum under the imaging unit. Doing so may affect the quality of future print jobs.</p> <p>b Remove any packing material that is stuck on the imaging unit.</p> <div data-bbox="396 638 786 783" data-label="Image"> </div> <p>Note: Make sure to remove any obstruction between the charge roller and photoconductor drum.</p> <p>c Insert the imaging unit.</p> <p>d Print the document.</p> <p>Are text or images cut off?</p>	<p>Go to step 4.</p>	<p>The problem is solved.</p>
<p>Step 4</p> <p>a Replace the imaging unit.</p> <p>b Print the document.</p> <p>Are text or images cut off?</p>	<p>Contact customer support.</p>	<p>The problem is solved.</p>

Toner easily rubs off



Note: Before solving the problem, print the Print Quality Test Pages. From the control panel, navigate to **Settings > Troubleshooting > Print Quality Test Pages**. For non-touch-screen printer models, press  to navigate through the settings.

Action	Yes	No
<p>Step 1</p> <p>a Check if the printer is using a genuine and supported toner cartridge.</p> <p>Note: If the toner cartridge is not supported, then install a supported one.</p> <p>b Print the document.</p> <p>Does the toner easily rub off?</p>	Go to step 2.	The problem is solved.
<p>Step 2</p> <p>a Depending on your operating system, specify the paper type from the Printing Preferences or Print dialog.</p> <p>Notes:</p> <ul style="list-style-type: none"> • Make sure that the setting matches the paper loaded. • You can also change the setting on the printer control panel. <p>b Print the document.</p> <p>Does the toner easily rub off?</p>	Contact customer support .	The problem is solved.

Vertical dark bands



Note: Before solving the problem, print the Print Quality Test Pages. From the control panel, navigate to **Settings > Troubleshooting > Print Quality Test Pages**. For non-touch-screen printer models, press  to navigate through the settings.

Action	Yes	No
<p>Step 1</p> <p>a Check if the printer is using a genuine and supported toner cartridge.</p> <p>Note: If the toner cartridge is not supported, then install a supported one.</p> <p>b Print the document.</p> <p>Do vertical dark bands appear on prints?</p>	Go to step 2.	The problem is solved.

Action	Yes	No
<p>Step 2</p> <p>a Remove the toner cartridge, and then remove the imaging unit.</p> <p>Warning—Potential Damage: Do not expose the imaging unit to direct light for more than 10 minutes. Extended exposure to light may cause print quality problems.</p> <p>Warning—Potential Damage: Do not touch the photoconductor drum under the imaging unit. Doing so may affect the quality of future print jobs.</p> <p>b Insert the imaging unit, and then insert the cartridge.</p> <p>c Print the document.</p> <p>Do vertical dark bands appear on prints?</p>	<p>Go to step 3.</p>	<p>The problem is solved.</p>
<p>Step 3</p> <p>a Remove the imaging unit.</p> <p>Warning—Potential Damage: Do not expose the imaging unit to direct light for more than 10 minutes. Extended exposure to light may cause print quality problems.</p> <p>Warning—Potential Damage: Do not touch the photoconductor drum under the imaging unit. Doing so may affect the quality of future print jobs.</p> <p>b Remove any packing material that is stuck on the imaging unit.</p> <div data-bbox="396 1094 786 1241" style="text-align: center;">  </div> <p>Note: Make sure to remove any obstruction between the charge roller and photoconductor drum.</p> <p>c Insert the imaging unit.</p> <p>d Print the document.</p> <p>Do vertical dark bands appear on prints?</p>	<p>Go to step 4.</p>	<p>The problem is solved.</p>
<p>Step 4</p> <p>a Check if a bright light enters the right side of the printer, and move the printer if necessary.</p> <p>b Print the document.</p> <p>Do vertical dark bands appear on prints?</p>	<p>Contact customer support.</p>	<p>The problem is solved.</p>

Vertical dark lines or streaks





Action	Yes	No
<p>Step 1</p> <p>a From the control panel, navigate to: Settings > Troubleshooting > Cleaning the scanner</p> <p>b Print the document.</p> <p>Do vertical dark lines or streaks appear on prints?</p>	Go to step 3.	Go to step 2.
<p>Step 2</p> <p>a Using a damp, soft, lint-free cloth, clean the scanner. For more information, see “Cleaning the scanner” on page 134.</p> <p>b Copy the document using the ADF.</p> <p>Do vertical dark lines or streaks appear on prints?</p>	Contact customer support .	The problem is solved.
<p>Step 3</p> <p>a Check if the printer is using a genuine and supported toner cartridge.</p> <p>Note: If the toner cartridge is not supported, then install a supported one.</p> <p>b Print the document.</p> <p>Do vertical dark lines or streaks appear on prints?</p>	Go to step 4.	The problem is solved.
<p>Step 4</p> <p>a Remove, and then insert the imaging unit.</p> <p>Warning—Potential Damage: Do not expose the imaging unit to direct light for more than 10 minutes. Extended exposure to light can cause print quality problems.</p> <p>Warning—Potential Damage: Do not touch the photoconductor drum under the imaging unit. Doing so may affect the quality of future print jobs.</p> <p>b Print the document.</p> <p>Do vertical dark lines or streaks appear on prints?</p>	Go to step 5.	The problem is solved.

Action	Yes	No
<p>Step 5</p> <p>a Replace the imaging unit.</p> <p>b Print the document.</p> <p>Do vertical dark lines or streaks appear on prints?</p>	<p>Contact customer support.</p>	<p>The problem is solved.</p>

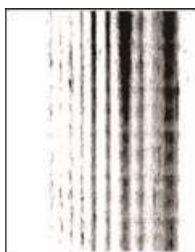
Vertical dark streaks with print missing



Note: Before solving the problem, print the Print Quality Test Pages. From the control panel, navigate to **Settings > Troubleshooting > Print Quality Test Pages**. For non-touch-screen printer models, press  to navigate through the settings.

Action	Yes	No
<p>Step 1</p> <p>a Remove the imaging unit.</p> <p>Warning—Potential Damage: Do not expose the imaging unit to direct light for more than 10 minutes. Extended exposure to light may cause print quality problems.</p> <p>Warning—Potential Damage: Do not touch the photoconductor drum under the imaging unit. Doing so may affect the quality of future print jobs.</p> <p>b Remove any packing material that is stuck on the imaging unit.</p> <div style="text-align: center;">  </div> <p>Note: Make sure to remove any obstruction between the charge roller and photoconductor drum.</p> <p>c Insert the imaging unit.</p> <p>d Print the document.</p> <p>Do vertical dark streaks with missing images appear on prints?</p>	<p>Go to step 2.</p>	<p>The problem is solved.</p>

Action	Yes	No
<p>Step 2</p> <p>a Check if the printer is using a genuine and supported toner cartridge.</p> <p>Note: If the toner cartridge is not supported, then install a supported one.</p> <p>b Print the document.</p> <p>Do vertical dark streaks with missing images appear on prints?</p>	<p>Contact customer support.</p>	<p>The problem is solved.</p>

Vertical light bands



Note: Before solving the problem, print the Print Quality Test Pages. From the control panel, navigate to

Settings > Troubleshooting > Print Quality Test Pages. For non-touch-screen printer models, press **OK** to navigate through the settings.

Action	Yes	No
<p>a Check if the printer is using a genuine and supported toner cartridge.</p> <p>Note: If the cartridge is not supported, then install a supported one.</p> <p>b Print the document.</p> <p>Do vertical light bands appear on prints?</p>	<p>Contact customer support.</p>	<p>The problem is solved.</p>

Vertical white lines



Note: Before solving the problem, print the Print Quality Test Pages. From the control panel, navigate to

Settings > Troubleshooting > Print Quality Test Pages. For non-touch-screen printer models, press **OK** to navigate through the settings.

Action	Yes	No
<p>Step 1</p> <p>a Check if the printer is using a genuine and supported toner cartridge.</p> <p>Note: If the cartridge is not supported, then install a supported one.</p> <p>b Print the document.</p> <p>Do vertical white lines appear on prints?</p>	Go to step 2.	The problem is solved.
<p>Step 2</p> <p>a Depending on your operating system, specify the paper type from the Printing Preferences or Print dialog.</p> <p>Notes:</p> <ul style="list-style-type: none"> • Make sure that the setting matches the paper loaded. • You can also change the setting on the printer control panel. <p>b Print the document.</p> <p>Do vertical white lines appear on prints?</p>	Contact customer support .	The problem is solved.

The printer is not responding

Action	Yes	No
<p>Step 1</p> <p>Check if the power cord is connected to the electrical outlet.</p> <p> CAUTION—POTENTIAL INJURY: To avoid the risk of fire or electrical shock, connect the power cord to an appropriately rated and properly grounded electrical outlet that is near the product and easily accessible.</p> <p>Is the printer responding?</p>	The problem is solved.	Go to step 2.
<p>Step 2</p> <p>Check if the electrical outlet is turned off by a switch or breaker.</p> <p>Is the electrical outlet turned off by a switch or breaker?</p>	Turn on the switch or reset the breaker.	Go to step 3.
<p>Step 3</p> <p>Check if the printer is on.</p> <p>Is the printer on?</p>	Go to step 4.	Turn on the printer.
<p>Step 4</p> <p>Check if the printer is in Sleep or Hibernate mode.</p> <p>Is the printer in Sleep or Hibernate mode?</p>	Press the power button to wake the printer.	Go to step 5.

Action	Yes	No
<p>Step 5</p> <p>Check if the cables connecting the printer and the computer are inserted to the correct ports.</p> <p>Are the cables inserted to the correct ports?</p>	Go to step 6.	Insert the cables to the correct ports.
<p>Step 6</p> <p>Turn off the printer, install the hardware options, and then turn on the printer.</p> <p>For more information, see the documentation that came with the option.</p> <p>Is the printer responding?</p>	The problem is solved.	Go to step 7.
<p>Step 7</p> <p>Install the correct print driver.</p> <p>Is the printer responding?</p>	The problem is solved.	Go to step 8.
<p>Step 8</p> <p>Turn off the printer, wait for about 10 seconds, and then turn on the printer.</p> <p>Is the printer responding?</p>	The problem is solved.	Contact customer support .

Adjusting toner darkness

- 1 From the home screen, touch **Settings > Print > Quality**.
- 2 Adjust the toner darkness.
- 3 Apply the changes.

Job prints from the wrong tray or on the wrong paper

Action	Yes	No
<p>Step 1</p> <p>a Check if you are printing on the correct paper.</p> <p>b Print the document.</p> <p>Is the document printed on the correct paper?</p>	Go to step 2.	Load the correct paper size and paper type.

Action	Yes	No
<p>Step 2</p> <p>a Depending on your operating system, specify the paper size and paper type from the Printing Preferences or Print dialog.</p> <p>Notes:</p> <ul style="list-style-type: none"> • Make sure that the settings match the paper loaded in the tray. • You can also change the settings on the printer control panel. <p>b Print the document.</p> <p>Is the document printed from the correct tray or on the correct paper?</p>	<p>The problem is solved.</p>	<p>Go to step 3.</p>
<p>Step 3</p> <p>a Check if the trays are not linked. For more information, see “Linking trays” on page 26.</p> <p>b Print the document.</p> <p>Is the document printed from the correct tray?</p>	<p>The problem is solved.</p>	<p>Contact customer support.</p>

Faxing problems

Cannot send or receive faxes

Action	Yes	No
<p>Step 1</p> <p>Resolve any error messages that appear on the display.</p> <p>Can you send or receive a fax?</p>	<p>The problem is solved.</p>	<p>Go to step 2.</p>
<p>Step 2</p> <p>Make sure that the cable connections for the following equipment are secure:</p> <ul style="list-style-type: none"> • Telephone • Handset • Answering machine <p>Can you send or receive a fax?</p>	<p>The problem is solved.</p>	<p>Go to step 3.</p>

Action	Yes	No
<p>Step 3</p> <p>Check for a dial tone.</p> <ul style="list-style-type: none"> • Call the fax number to check if it is working properly. • If you are using the On Hook Dial feature, then turn up the volume to check if you hear a dial tone. <p>Can you hear a dial tone?</p>	<p>Go to step 5.</p>	<p>Go to step 4.</p>
<p>Step 4</p> <p>Check the telephone wall jack.</p> <ol style="list-style-type: none"> a Connect the analog telephone directly to the wall jack. b Listen for a dial tone. c If you do not hear a dial tone, then use a different telephone cable. d If you still do not hear a dial tone, then connect the analog telephone to a different wall jack. e If you hear a dial tone, then connect the printer to that wall jack. <p>Can you send or receive a fax?</p>	<p>The problem is solved.</p>	<p>Go to step 5.</p>
<p>Step 5</p> <p>Check if the printer is connected to an analog phone service or to the correct digital connector.</p> <ul style="list-style-type: none"> • If you are using an Integrated Services for Digital Network (ISDN) telephone service, then connect to an analog telephone port of an ISDN terminal adapter. For more information, contact your ISDN provider. • If you are using DSL, then connect to a DSL filter or router that supports analog use. For more information, contact your DSL provider. • If you are using a private branch exchange (PBX) telephone service, then make sure that you are connecting to an analog connection on the PBX. If none exists, then consider installing an analog telephone line for the fax machine. <p>Can you send or receive a fax?</p>	<p>The problem is solved.</p>	<p>Go to step 6.</p>
<p>Step 6</p> <p>Temporarily disconnect other equipment and disable other telephone services.</p> <ol style="list-style-type: none"> a Disconnect other equipment (such as answering machines, computers, modems, or telephone line splitters) between the printer and the telephone line. b Disable call waiting and voice mail. For more information, contact your telephone company. <p>Can you send or receive a fax?</p>	<p>The problem is solved.</p>	<p>Go to step 7.</p>

Action	Yes	No
<p>Step 7 Scan the original document one page at a time.</p> <ul style="list-style-type: none"> a Dial the fax number. b Scan the document. <p>Can you send or receive a fax?</p>	The problem is solved.	Contact customer support .

Can receive but not send faxes

Action	Yes	No
<p>Step 1 Load the original document properly into the ADF tray or on the scanner glass.</p> <p>Can you send faxes?</p>	The problem is solved.	Go to step 2.
<p>Step 2 Set up the shortcut number properly.</p> <ul style="list-style-type: none"> • Check if the shortcut number is set for the telephone number that you want to dial. • Dial the telephone number manually. <p>Can you send faxes?</p>	The problem is solved.	Contact customer support .

Can send but not receive faxes

Action	Yes	No
<p>Step 1 Make sure that the paper source is not empty.</p> <p>Can you receive faxes?</p>	The problem is solved.	Go to step 2.
<p>Step 2 Check the ring count delay settings. From the control panel, navigate to: Settings > Fax > Analog Fax Setup > Fax Receive Settings > Rings to Answer</p> <p>For non-touch-screen printer models, press  to navigate through the settings.</p> <p>Can you receive faxes?</p>	The problem is solved.	Contact customer support .

Poor fax print quality

Action	Yes	No
<p>Step 1 Enhance the print quality.</p> <p>a From the home screen, touch Settings > Print > Quality.</p> <p>b Adjust the settings.</p> <p>Is the fax print quality satisfactory?</p>	The problem is solved.	Go to step 2.
<p>Step 2 Decrease the incoming fax transmission speed.</p> <p>a From the home screen, touch Settings > Fax > Analog Fax Setup > Fax Receive Settings > Admin Controls > Max Speed.</p> <p>b Select a lower transmission speed.</p> <p>Is the fax print quality satisfactory?</p>	The problem is solved.	Go to step 3.
<p>Step 3 Replace the toner cartridge.</p> <p>For more information, see the instruction sheet that came with the supply.</p> <p>Is the fax print quality satisfactory?</p>	The problem is solved.	Contact customer support .

Scanning problems

Cannot scan from a computer

Action	Yes	No
<p>Step 1</p> <p>a Turn off the printer, wait for about 10 seconds, and then turn it back on.</p> <p>b Resend the scan job.</p> <p>Can you send the scan job?</p>	The problem is solved.	Go to step 2.
<p>Step 2</p> <p>a Make sure that the cables between the printer and the print server are secure.</p> <p>For more information, see the setup documentation that came with the printer.</p> <p>b Resend the scan job.</p> <p>Can you send the scan job?</p>	The problem is solved.	Contact customer support .

Partial copies of document or photo

Action	Yes	No
<p>Step 1</p> <p>a Make sure that the document or photo is loaded facedown on the upper left corner of the scanner glass.</p> <p>b Copy the document or photo.</p> <p>Is the document or photo copied correctly?</p>	The problem is solved.	Go to step 2.
<p>Step 2</p> <p>a Match the paper size setting and the paper loaded in the tray.</p> <p>b Copy the document or photo.</p> <p>Is the document or photo copied correctly?</p>	The problem is solved.	Contact customer support .

Poor copy quality

Action	Yes	No
<p>Step 1</p> <p>a Using a damp, soft, lint-free cloth, wipe the scanner glass and the ADF glass.</p> <p>b Make sure that the document or photo is loaded facedown on the upper-left corner of the scanner glass.</p> <p>c Copy the document or photo.</p> <p>Is the copy quality satisfactory?</p>	The problem is solved.	Go to step 2.
<p>Step 2</p> <p>a Check the quality of the original document or photo.</p> <p>b Adjust the scan quality settings.</p> <p>c Copy the document or photo.</p> <p>Is the copy quality satisfactory?</p>	The problem is solved.	Contact customer support .

Vertical dark streaks on output when scanning from the ADF

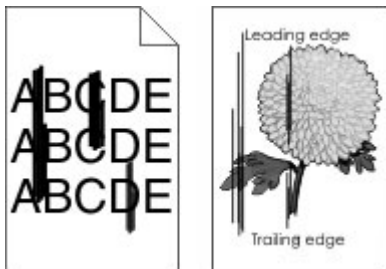

Action	Yes	No
<p>Step 1</p> <p>a Open the scanner cover.</p> <p>b Using a damp, soft, lint-free cloth, wipe the ADF glass and the white underside of the ADF cover.</p> <p>c Close the scanner cover.</p> <p>Do vertical streaks still appear on scanned documents?</p>	Go to step 2.	The problem is solved.
<p>Step 2</p> <p>a Open door C.</p> <p>b Using a damp, soft, lint-free cloth, wipe the ADF glass and the white underside of the ADF cover.</p> <p>c Close the door.</p> <p>Do vertical streaks still appear on scanned documents?</p>	Contact customer support .	The problem is solved.

Scan job was not successful

Action	Yes	No
<p>Step 1</p> <p>Check the cable connections.</p> <p>a Make sure that the Ethernet or USB cable is securely connected to the computer and the printer.</p> <p>b Resend the scan job.</p> <p>Is the scan job successful?</p>	The problem is solved.	Go to step 2.
<p>Step 2</p> <p>Check the file you want to scan.</p> <p>a Make sure that the file name is not already used in the destination folder.</p> <p>b Make sure that the document or photo you want to scan is not open in another application.</p> <p>c Resend the scan job.</p> <p>Is the scan job successful?</p>	The problem is solved.	Go to step 3.
<p>Step 3</p> <p>a Make sure that the Append time stamp or the Overwrite existing file check box is selected in the destination configuration settings.</p> <p>b Resend the scan job.</p> <p>Is the scan job successful?</p>	The problem is solved.	Contact customer support .

Scanner does not close

Action	Yes	No
Remove obstructions that keep the scanner unit open. Did the scanner unit close correctly?	The problem is solved.	Contact customer support .

Scanning takes too long or freezes the computer

Action	Yes	No
Close all applications that are interfering with the scan. Does scanning take too long or freeze the computer?	Contact customer support .	The problem is solved.

Scanner does not respond

Action	Yes	No
<p>Step 1</p> <ul style="list-style-type: none"> a Check if the printer is turned on. b Resolve any error messages that appear on the display. c Copy or scan the document. <p>Is the scanner responding?</p>	The problem is solved.	Go to step 2.
<p>Step 2</p> <ul style="list-style-type: none"> a Check if the power cord is connected properly to the printer and the electrical outlet. <p> CAUTION—POTENTIAL INJURY: To avoid the risk of fire or electrical shock, connect the power cord to an appropriately rated and properly grounded electrical outlet that is near the product and easily accessible.</p> <ul style="list-style-type: none"> b Copy or scan the document. <p>Is the scanner responding?</p>	The problem is solved.	Go to step 3.
<p>Step 3</p> <ul style="list-style-type: none"> a Turn off the printer, wait for about 10 seconds, and then turn it back on. b Copy or scan the document. <p>Is the scanner responding?</p>	The problem is solved.	Contact customer support .

Adjusting scanner registration

- 1 From the control panel, navigate to:
Settings > Maintenance > Configuration Menu > Scanner Configuration > Scanner Manual Registration
- 2 From the Print Quick Test menu, touch **Start**.
- 3 Place the Print Quick Test page on the scanner glass, and then touch **Flatbed Registration**.
- 4 From the Copy Quick Test menu, touch **Start**.
- 5 Compare the Copy Quick Test page with the original document.
Note: If the margins of the test page are different from the original document, then adjust Left Margin and Top Margin.
- 6 Repeat [step 4](#) and [step 5](#) until the margins of the Copy Quick Test page closely match the original document.

Adjusting ADF registration

- 1 From the control panel, navigate to:
Settings > Maintenance > Configuration Menu > Scanner Configuration > Scanner Manual Registration
- 2 From the Print Quick Test menu, touch **Start**.
- 3 Place the Print Quick Test page on the ADF tray.
- 4 Touch **Front ADF Registration** or **Rear ADF Registration**.
Notes:
 - To align Front ADF Registration, place the test page faceup, short edge first into the ADF.
 - To align Rear ADF Registration, place the test page facedown, short edge first into the ADF.
- 5 From the Copy Quick Test menu, touch **Start**.
- 6 Compare the Copy Quick Test page with the original document.
Note: If the margins of the test page are different from the original document, then adjust Horizontal Adjust and Top Margin.
- 7 Repeat [step 5](#) and [step 6](#) until the margins of the Copy Quick Test page closely match the original document.

Contacting customer support

Before contacting customer support, make sure to have the following information:

- Printer problem
- Error message
- Printer model type and serial number

Visit the place where you purchased your printer.

Upgrading and migrating

Hardware

Available internal options

- Flash memory
- Font cards
- Firmware cards
 - Forms and Bar Code
 - IPDS
 - PRESCRIBE
- Internal solutions port
 - RS-232C Serial Interface Card
 - Parallel 1284-B Interface Card
 - MarkNet N8230 Fiber Ethernet

Note: The internal solution port is supported only in MX521 and MX522 printer models.

Accessing the controller board



CAUTION—SHOCK HAZARD: To avoid the risk of electrical shock, if you are accessing the controller board or installing optional hardware or memory devices sometime after setting up the printer, then turn the printer off, and unplug the power cord from the electrical outlet before continuing. If you have any other devices attached to the printer, then turn them off as well, and unplug any cables going into the printer.

- 1** Turn off the printer.
- 2** Unplug the power cord from the electrical outlet, and then from the printer.
- 3** Using a flat-head screwdriver, open the controller board access cover.

Warning—Potential Damage: Controller board electronic components are easily damaged by static electricity. Touch a metal surface on the printer before touching any controller board components or connectors.

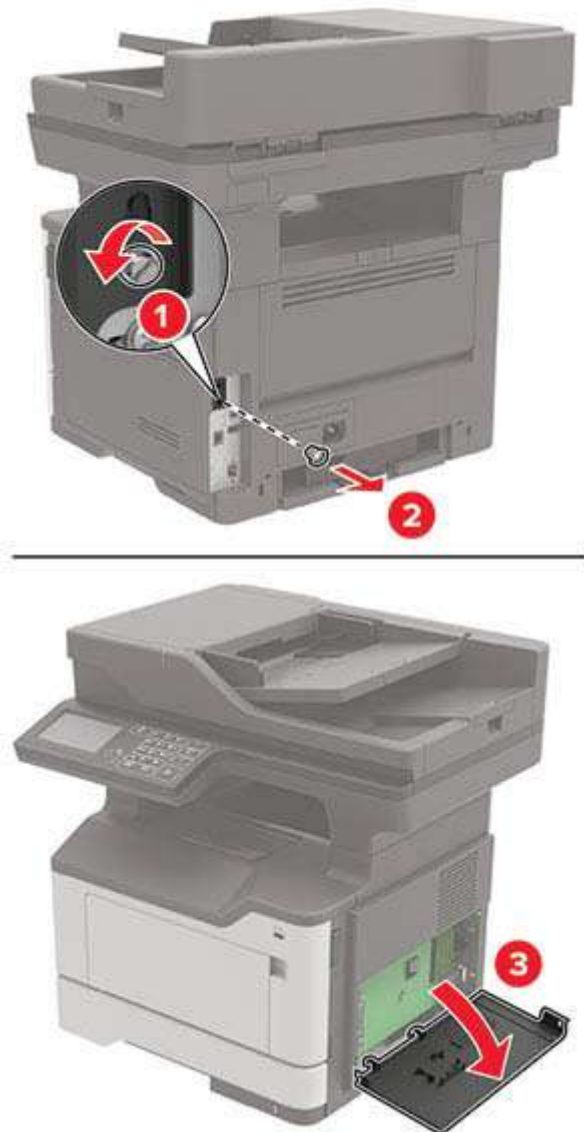

4 Close the access cover.

5 Connect the power cord to the printer, and then to the electrical outlet.

⚠ CAUTION—POTENTIAL INJURY: To avoid the risk of fire or electrical shock, connect the power cord to an appropriately rated and properly grounded electrical outlet that is near the product and easily accessible.

6 Turn on the printer.

Installing an optional card

⚠ CAUTION—SHOCK HAZARD: To avoid the risk of electrical shock, if you are accessing the controller board or installing optional hardware or memory devices sometime after setting up the printer, then turn the printer off, and unplug the power cord from the electrical outlet before continuing. If you have any other devices attached to the printer, then turn them off as well, and unplug any cables going into the printer.

- 1 Turn off the printer.
- 2 Unplug the power cord from the electrical outlet, and then from the printer.
- 3 Open the controller board access cover.

Warning—Potential Damage: Controller board electronic components are easily damaged by static electricity. Touch a metal surface on the printer before touching any components or connectors.

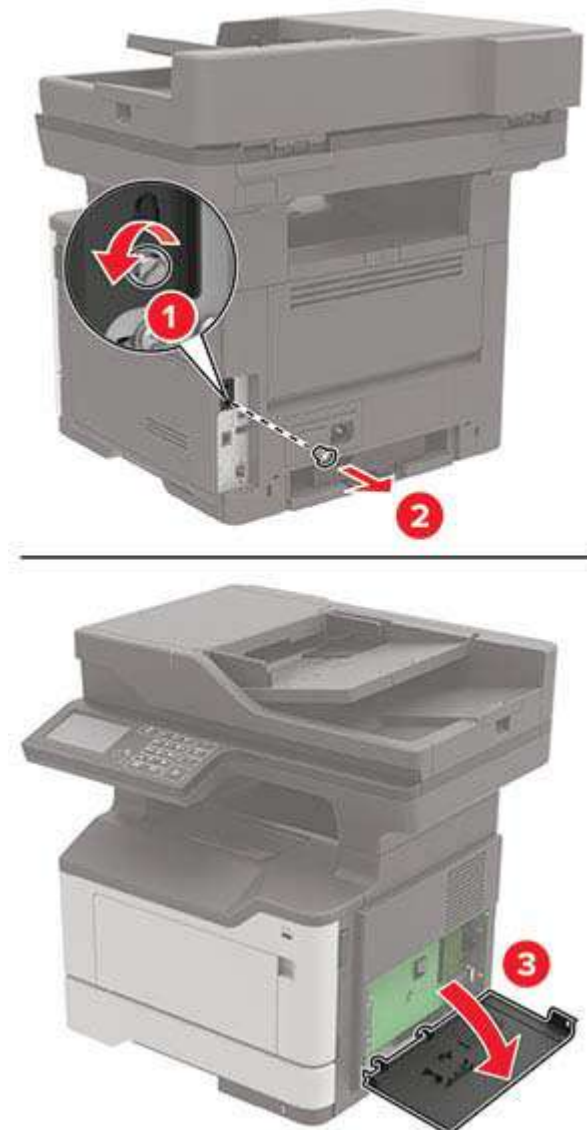

- 4 Unpack the optional card.

Warning—Potential Damage: Do not touch the connection points along the edge of the card.

- 5 Push the card firmly into place.

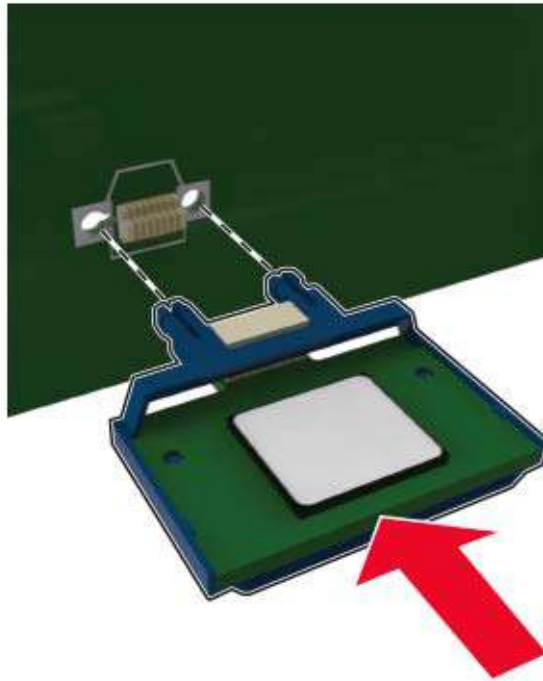

Note: The entire length of the connector on the card must touch and be flush against the controller board.

Warning—Potential Damage: Improper installation of the card may cause damage to the card and the controller board.

- 6 Close the access cover.
- 7 Connect the power cord to the printer, and then to the electrical outlet.



CAUTION—POTENTIAL INJURY: To avoid the risk of fire or electrical shock, connect the power cord to an appropriately rated and properly grounded electrical outlet that is near the product and easily accessible.

- 8 Turn on the printer.

Installing optional trays



CAUTION—SHOCK HAZARD: To avoid the risk of electrical shock, if you are accessing the controller board or installing optional hardware or memory devices sometime after setting up the printer, then turn the printer off, and unplug the power cord from the electrical outlet before continuing. If you have any other devices attached to the printer, then turn them off as well, and unplug any cables going into the printer.

- 1 Turn off the printer.
- 2 Unplug the power cord from the electrical outlet, and then from the printer.

- 3 Unpack the optional tray, and then remove all packing material.

Note: If optional trays are already installed, then unlock them from the printer before lifting the printer. Do not try to lift the printer and trays at the same time.

- 4 Align the printer with the optional tray, and then lower the printer until it *clicks* into place.



CAUTION—POTENTIAL INJURY: If the printer weight is greater than 18 kg (40 lb), then it requires two or more trained personnel to lift it safely.



- 5 Connect the power cord to the printer, and then to the electrical outlet.



CAUTION—POTENTIAL INJURY: To avoid the risk of fire or electrical shock, connect the power cord to an appropriately rated and properly grounded electrical outlet that is near the product and easily accessible.

- 6 Turn on the printer.

Add the tray in the print driver to make it available for print jobs. For more information, see [“Adding available options in the print driver” on page 210](#).

Software

Supported operating systems

Using the software CD, you can install the printer software on the following operating systems:

- Windows 10
- Windows 8.1
- Windows 8
- Windows Server 2016
- Windows Server 2012 R2
- Windows Server 2012
- Windows 7 SP1

- Windows Server 2008 R2 SP1
- Windows Server 2008 SP1
- Windows Server 2003
- Windows Vista SP1
- Windows XP
- Mac OS X version 10.7 or later
- Red Hat Enterprise Linux WS
- openSUSE Linux
- SUSE Linux Enterprise Server
- Debian GNU/Linux
- Ubuntu
- Fedora

Notes:

- For Windows operating systems, the print drivers and utilities are supported in both 32- and 64-bit versions.
- For drivers and utilities that are compatible with Mac OS X version 10.6 or earlier and for specific supported Linux or UNIX operating system versions, go to our website.
- For more information on software compatibility with all other operating systems, contact customer support.

Installing the printer software

- 1 Obtain a copy of the software installer package.
 - From the software CD that came with your printer.
 - From our website or the place where you purchased the printer.
- 2 Run the installer, and then follow the instructions on the computer screen.
- 3 For Macintosh users, add the printer.

Note: Obtain the printer IP address from the TCP/IP section in the Network/Ports menu.

Adding available options in the print driver

For Windows users

- 1 Open the printers folder.
- 2 Select the printer you want to update, and then do either of the following:
 - For Windows 7 or later, select **Printer properties**.
 - For earlier versions, select **Properties**.
- 3 Navigate to the Configuration tab, and then select **Update Now - Ask Printer**.
- 4 Apply the changes.

For Macintosh users

- 1 From System Preferences in the Apple menu, navigate to your printer, and then select **Options & Supplies**.
- 2 Navigate to the list of hardware options, and then add any installed options.
- 3 Apply the changes.

Firmware

Exporting or importing a configuration file

You can export the configuration settings of your printer into a text file, and then import the file to apply the settings to other printers.

- 1 Open a web browser, and then type the printer IP address in the address field.

Notes:

- View the printer IP address on the printer home screen. The IP address appears as four sets of numbers separated by periods, such as 123.123.123.123.
- If you are using a proxy server, then temporarily disable it to load the web page correctly.

- 2 Export or import a configuration file for one or multiple applications.

For one application

- a From the Embedded Web Server, click **Apps** > the application that you want > **Configure**.
- b Click **Export** or **Import**.

For multiple applications

- a From the Embedded Web Server, click **Export Configuration** or **Import Configuration**.
- b Follow the instructions on the screen.

Updating firmware

Some applications require a minimum device firmware level to operate correctly.

For more information on updating the device firmware, contact your sales representative.

- 1 From the Embedded Web Server, click **Settings** > **Device** > **Update Firmware**.
- 2 Browse to locate the required flash file.
- 3 Apply the changes.

Notices

Product information

Product name:
 Mono Laser MFP
 Machine type:
 7017
 Model(s):
 476, 678, and their equivalent models

Edition notice

September 2018

The following paragraph does not apply to any country where such provisions are inconsistent with local law: THIS PUBLICATION IS PROVIDED “AS IS” WITHOUT WARRANTY OF ANY KIND, EITHER EXPRESS OR IMPLIED, INCLUDING, BUT NOT LIMITED TO, THE IMPLIED WARRANTIES OF MERCHANTABILITY OR FITNESS FOR A PARTICULAR PURPOSE. Some states do not allow disclaimer of express or implied warranties in certain transactions; therefore, this statement may not apply to you.

This publication could include technical inaccuracies or typographical errors. Changes are periodically made to the information herein; these changes will be incorporated in later editions. Improvements or changes in the products or the programs described may be made at any time.

Licensing notices

All licensing notices associated with this product can be viewed from the program folder.

Noise emission levels

The following measurements were made in accordance with ISO 7779 and reported in conformance with ISO 9296.

Note: Some modes may not apply to your product.

1-meter average sound pressure, dBA	
Printing	56 (One-sided); 55 (Two-sided)
Scanning	55
Copying	55
Ready	14

Waste from Electrical and Electronic Equipment (WEEE) directive



The WEEE logo signifies specific recycling programs and procedures for electronic products in countries of the European Union. We encourage the recycling of our products. If you have further questions about recycling options, contact your local sales office.

Product disposal

Do not dispose of the printer or supplies in the same manner as normal household waste. Consult your local authorities for disposal and recycling options.

Static sensitivity notice



This symbol identifies static-sensitive parts. Do not touch the areas near these symbols without first touching a metal surface in an area away from the symbol.

Temperature information

Ambient operating temperature	10 to 32°C (50 to 90°F)
Shipping temperature	-20 to 40°C (-4 to 104°F)
Storage temperature and relative humidity	0 to 40°C (32 to 104°F) 8 to 80% RH

Laser notice

The printer is certified in the U.S. to conform to the requirements of DHHS 21 CFR, Chapter I, Subchapter J for Class I (1) laser products, and elsewhere is certified as a Class I laser product conforming to the requirements of IEC 60825-1: 2014.

Class I laser products are not considered to be hazardous. The printer contains internally a Class IIIb (3b) AlGaInP laser that is nominally 15 milliwatts operating in the wavelength region of 650–670 nanometers and enclosed in a non-serviceable printhead assembly. The laser system and printer are designed so there is never any human

access to laser radiation above a Class I level during normal operation, user maintenance, or prescribed service conditions.

Power consumption

Product power consumption

The following table documents the power consumption characteristics of the product.

Note: Some modes may not apply to your product.

Mode	Description	Power consumption (Watts)
Printing	The product is generating hard-copy output from electronic inputs.	620 (One-sided); 385 (Two-sided)
Copy	The product is generating hard-copy output from hard-copy original documents.	630
Scan	The product is scanning hard-copy documents.	20
Ready	The product is waiting for a print job.	14.5
Sleep Mode	The product is in a high-level energy-saving mode.	2.6
Hibernate	The product is in a low-level energy-saving mode.	0.1
Off	The product is plugged into an electrical outlet, but the power switch is turned off.	0.1

The power consumption levels listed in the previous table represent time-averaged measurements. Instantaneous power draws may be substantially higher than the average.

Sleep Mode

This product is designed with an energy-saving mode called *Sleep Mode*. The Sleep Mode saves energy by lowering power consumption during extended periods of inactivity. The Sleep Mode is automatically engaged after this product is not used for a specified period of time, called the *Sleep Mode Timeout*.

Factory default Sleep Mode Timeout for this product (in minutes):	15
---	----

By using the configuration menus, the Sleep Mode Timeout can be modified between 1 minute and 120 minutes. Setting the Sleep Mode Timeout to a low value reduces energy consumption, but may increase the response time of the product. Setting the Sleep Mode Timeout to a high value maintains a fast response, but uses more energy.

Hibernate Mode

This product is designed with an ultra-low power operating mode called *Hibernate mode*. When operating in Hibernate Mode, all other systems and devices are powered down safely.

The Hibernate mode can be entered in any of the following methods:

- Using the Hibernate Timeout
- Using the Schedule Power modes

Factory default Hibernate Timeout for this product in all countries or regions	3 days
--	--------

The amount of time the printer waits after a job is printed before it enters Hibernate mode can be modified between one hour and one month.

Off mode

If this product has an off mode which still consumes a small amount of power, then to completely stop product power consumption, disconnect the power supply cord from the electrical outlet.

Total energy usage

It is sometimes helpful to calculate the total product energy usage. Since power consumption claims are provided in power units of Watts, the power consumption should be multiplied by the time the product spends in each mode in order to calculate energy usage. The total product energy usage is the sum of each mode's energy usage.

Regulatory notices for telecommunication terminal equipment

This section contains regulatory information pertaining to products that contain the analog facsimile card:

Regulatory Type/Model Number:

LEX-M14-002

Modular component notice

This product may contain the following modular component(s):

Regulatory Type/LEX-M01-005

Notice to users of Class A products in Brazil

Este produto não é apropriado para uso em ambientes domésticos, pois poderá causar interferências eletromagnéticas que obrigam o usuário a tomar medidas necessárias para minimizar estas interferências.

Radio interference notice

Warning

This is a product that complies with the emission requirements of EN55022 and EN55032 Class A limits and immunity requirements of EN55024. This product is not intended to be used in residential/domestic environments.

This is a Class A product. In a domestic environment, this product may cause radio interference, in which case the user may be required to take adequate measures.

Index

A

- accessing the controller board 205
- activating Voice Guidance 21
- adapter plug 41
- adding contacts 18
- adding groups 19
- adding hardware options
 - print driver 210
- adding internal options
 - print driver 210
- adjusting
 - ADF registration 204
 - scanner registration 204
- adjusting speech rate
 - Voice Guidance 21
- adjusting the brightness
 - printer display 149
- adjusting the brightness of the printer display 149
- adjusting the default speaker volume 131
- adjusting toner darkness 196
- AirPrint
 - using 30
- answering machine
 - setting up 39
- attaching cables 12
- avoiding paper jams 151

B

- blank pages 172
- blocking junk faxes 46

C

- can send but not receive faxes 199
- canceling a print job
 - from the computer 34
 - from the printer control panel 34
- cannot open Embedded Web Server 163
- Card Copy
 - setting up 17
- changing the printer port settings after installing ISP 133

- checking the status of parts and supplies 137
- cleaning
 - exterior of the printer 133
 - interior of the printer 133
- cleaning the printer 133
- cleaning the scanner 126, 134
- clearing jam
 - in door A 153
 - in the duplex unit 159
 - in the rear door 157
 - in trays 160
- clearing jams
 - in the standard bin 158
- collated printing does not work 167
- collating copies 36
- confidential print jobs 33
- configuring daylight saving time 44
- configuring e-mail settings 37
- configuring fax speaker settings 131
- configuring supply notifications 137
- connecting printer to distinctive ring service 44
- connecting the printer
 - to a wireless network 131
- connecting to a wireless network
 - using PIN method 132
 - using Push Button method 132
- conserving supplies 150
- contacting customer support 204
- contacts
 - adding 18
 - deleting 19
 - editing 19
- control panel
 - using 14
- controller board
 - accessing 205
- copy troubleshooting
 - partial copies of documents or photos 201
 - poor copy quality 201
 - scanner does not respond 203

- scanner unit does not close 203
- copying
 - creating shortcuts 36
 - on both sides of the paper 35
- copying different paper sizes 35
- copying from
 - selected tray 35
- copying multiple pages
 - onto a single sheet 36
- copying on letterhead 35
- copying photos 35
- creating shortcuts
 - e-mail 38
 - fax destination 45
- crooked print 185
- customer support
 - contacting 204
- customizing the display 18

D

- date and time
 - fax settings 44
- daylight saving time, configuring 44
- deactivating the Wi-Fi network 132
- default speaker volume
 - adjusting 131
- deleting contacts 19
- deleting groups 19
- different paper sizes, copying 35
- Display Customization
 - using 18
- distinctive ring service, fax
 - connecting to 44
- documents, printing
 - from a mobile device 30
- dots on print 182

E

- Eco-Mode
 - configuring 149
- editing contacts 19
- editing groups 19
- emission notices 212
- enabling Magnification mode 21

- enabling personal identification numbers 21
- enabling spoken passwords 21
- enabling the USB port 164
- encrypting
 - printer hard disk 129
- enlarging copies 36
- environmental settings 149
- erasing printer hard disk memory 128
- erasing printer memory 129
- Ethernet menu 102
- Ethernet port 12
- exporting a configuration file using the Embedded Web Server 211
- e-mail
 - creating shortcuts 38
 - setting up 37
- e-mailing
 - configuring e-mail settings 37
 - using a shortcut number 37
 - using the address book 37
 - using the printer 37

F

- fax log
 - viewing 46
- fax resolution
 - changing 45
- fax setup
 - country- or region-specific 41
 - standard telephone line connection 39
- fax speaker settings
 - configuring 131
- fax troubleshooting
 - cannot receive faxes 199
 - cannot send faxes 199
 - cannot send or receive faxes 197
 - received fax has poor print quality 200
- faxing
 - adjusting darkness 45
 - blocking junk faxes 46
 - changing resolution 45
 - creating shortcuts 45
 - fax setup 39
 - forwarding faxes 46
 - holding faxes 46
 - setting the date and time 44

- viewing a fax log 46
- firmware
 - update 211
- flash drive
 - printing from 31
 - scanning to 47
- folder paper 176
- font sample list
 - printing 33
- forwarding faxes 46
- FTP address
 - creating shortcuts 47
- FTP server, scanning to using the control panel 47

G

- Google Cloud Print
 - using 30
- groups
 - adding 19
 - deleting 19
 - editing 19

H

- hardware options
 - trays 208
- hardware options, adding
 - print driver 210
- held jobs 33
 - printing from a Macintosh computer 33
 - printing from Windows 33
- held print jobs
 - printing from a Macintosh computer 33
 - printing from Windows 33
- Help menu 126
- Hibernate mode
 - configuring 149
- holding faxes 46
- home screen
 - customizing 17
 - showing icons 17
 - using 15
- home screen icons 15
- HTTP/FTP Settings menu 108

I

- icons on the home screen
 - showing 17
- identifying jam locations 152

- imaging unit
 - ordering 137
 - replacing 139
- importing a configuration file using the Embedded Web Server 211
- indicator light
 - understanding the status 14
- installing an optional card 207
- installing the printer software 210
- internal options
 - firmware cards 205
 - flash memory 205
 - font cards 205
 - installing 207
 - internal solutions port 205
- internal options, adding
 - print driver 210

J

- jams
 - avoiding 151
- jams, clearing
 - in the automatic document feeder 162
 - in the multipurpose feeder 161

K

- keyboard on the display
 - using 22

L

- letterhead
 - copying on 35
- LINE port 12
- linking trays 26
- loading
 - multipurpose feeder 25
- loading envelopes
 - in the multipurpose feeder 25
- loading trays 23
- locating paper jams 152
- locating the security slot 128

M

- Magnification mode
 - enabling 21
- making copies 35
- Media Types menu 71

- menu
 - 802.1x 107
 - About this Printer 60
 - Accessibility 55
 - Confidential Print Setup 122
 - Configuration Menu 56
 - Copy Defaults 72
 - Custom Scan Sizes 71
 - Device 125
 - Erase Temporary Data Files 123
 - Ethernet 102
 - E-mail Defaults 89
 - E-mail Setup 88
 - Fax 125
 - Fax Cover Page 83
 - Fax Log Settings 84
 - Fax Mode 75
 - Fax Receive Settings 80
 - Fax Send Settings 77
 - Fax Server E-mail Settings 85
 - Fax Server Scan Settings 87
 - Flash Drive Print 115
 - Flash Drive Scan 111
 - FTP Defaults 95
 - General Fax Settings 75, 85
 - Google Cloud Print 109
 - HTML 68
 - HTTP/FTP Settings 108
 - Image 69
 - IPSec 106
 - Job Accounting 63
 - Layout 61
 - Local Accounts 118
 - Login Restrictions 122
 - LPD Configuration 107
 - Manage Permissions 117
 - Media Types 71
 - Menu Settings Page 125
 - Miscellaneous 124
 - Mobile Services
 - Management 124
 - Network 126
 - Network Overview 99
 - Notifications 52
 - Out of Service Erase 60
 - PCL 66
 - PDF 65
 - PostScript 66
 - Power Management 54
 - Preferences 50
 - Print 125
 - Quality 64
 - Remote Operator Panel 52
 - Security Audit Log 119
 - Setup 62
 - Shortcuts 125
 - SNMP 105
 - Solutions LDAP Settings 123
 - Speaker Settings 84
 - TCP/IP 104
 - ThinPrint 109
 - Tray Configuration 69
 - Troubleshooting 126
 - Universal Setup 70
 - USB 109
 - Web Link Setup 94
 - Wi-Fi Direct 110
 - XPS 65
 - Menu Settings Page
 - printing 127
 - menus
 - Disk Encryption 123
 - Restore Factory Defaults 56
 - Schedule USB Devices 119
 - Visible Home Screen Icons 60
 - Wireless 100
 - mobile device
 - printing from 30
 - Mopria Print Service
 - using 30
 - mottled print 182
 - moving the printer 10, 148
 - multipurpose feeder
 - loading 25
- N**
- navigating the screen
 - using gestures 22
 - navigating the screen using gestures 22
 - Network Setup Page
 - printing 16
 - network setup page
 - printing 164
 - noise emission levels 212
 - Non-Printer Manufacturer supply 166
 - non-volatile memory 129
 - erasing 128
 - notices 212, 213, 214, 215
- O**
- operating systems
 - supported 209
 - optional card
 - installing 207
 - ordering
 - imaging unit 137
 - toner cartridge 137
- P**
- paper
 - Universal size setting 23
 - paper jam in door A 153
 - paper jam in the automatic document feeder 162
 - paper jam in the duplex unit 159
 - paper jam in the multipurpose feeder 161
 - paper jam in the rear door 157
 - paper jam in the standard bin 158
 - paper jam in trays 160
 - paper jam, clearing
 - in the automatic document feeder 162
 - in the multipurpose feeder 161
 - in the standard bin 158
 - paper jams
 - avoiding 151
 - paper size
 - setting 23
 - paper type
 - setting 23
 - parts status
 - checking 137
 - personal identification number method 132
 - personal identification numbers
 - enabling 21
 - photos
 - copying 35
 - pick roller assembly
 - replacing 144
 - pick tires
 - replacing 142
 - placing separator sheets
 - between copies
 - copying 36
 - power button light
 - understanding the status 14
 - power cord socket 12

- power save modes
 - configuring 149
 - print driver
 - hardware options, adding 210
 - print job
 - canceling from the
 - computer 34
 - canceling from the printer control panel 34
 - print quality troubleshooting
 - blank or white pages 172
 - crooked or skewed print 185
 - dark print 173
 - fine lines are not printed correctly 175
 - folded or wrinkled paper 176
 - gray background on prints 177
 - horizontal light bands 179
 - light print 180
 - mottled print and dots 182
 - paper curl 183
 - repeating defects 185
 - solid black pages 186
 - text or images cut off 188
 - toner easily rubs off 189
 - vertical dark bands 190
 - vertical dark lines or streaks 192
 - vertical dark streaks with print missing 193
 - vertical light bands 194
 - vertical white lines 194
 - print troubleshooting
 - confidential and other held documents do not print 169
 - envelope seals when printing 166
 - incorrect margins 179
 - jammed pages are not reprinted 168
 - job prints from the wrong tray 196
 - job prints on the wrong paper 196
 - paper frequently jams 168
 - print jobs do not print 171
 - slow printing 170
 - tray linking does not work 167
 - unable to read flash drive 164
 - printer
 - minimum clearances 10
 - selecting a location 10
 - shipping 149
 - printer configurations 11
 - printer display
 - adjusting the brightness 149
 - printer hard disk
 - encrypting 129
 - printer hard disk memory 129
 - erasing 128
 - printer is not responding 195
 - printer menus 49
 - printer messages
 - Non-Printer Manufacturer supply 166
 - Replace cartridge, printer region mismatch 166
 - Scanner maintenance required, use ADF Kit 166
 - printer options troubleshooting
 - internal option is not detected 165
 - printer port settings
 - changing 133
 - printer ports 12
 - printer settings
 - restoring to factory defaults 129
 - printer software, installing 210
 - printer status 14
 - printing
 - font sample list 33
 - from a computer 30
 - from a flash drive 31
 - from a mobile device 30
 - Menu Settings Page 127
 - Network Setup Page 16
 - network setup page 164
 - quality test pages 126
 - printing a font sample list 33
 - printing a network setup page 164
 - printing from a computer 30
 - printing from a flash drive 31
 - printing held jobs
 - from a Macintosh computer 33
 - from Windows 33
 - Push Button method 132
- Q**
- Quality menu 64
- R**
- reducing copies 36
 - removing jam
 - in the duplex unit 159
 - in the rear door 157
 - removing paper jam
 - in door A 153
 - in trays 160
 - repeat print jobs 33
 - Replace cartridge, printer region mismatch 166
 - replacing parts
 - pick roller assembly 144
 - pick tires 142
 - replacing supplies
 - imaging unit 139
 - toner cartridge 137
 - reserve print jobs
 - printing from Windows 33
 - restoring factory default settings 129
 - RJ11 adapter 41
- S**
- safety information 8, 9
 - saving paper 36
 - saving toner 36
 - Scan Center
 - setting up 18
 - Scan to Computer
 - setting up 48
 - scan troubleshooting
 - cannot scan from a computer 200
 - partial copies of documents or photos 201
 - poor copy quality 201
 - scan job was not successful 202
 - scanner does not respond 203
 - scanner unit does not close 203
 - scanning freezes the computer 203
 - scanning takes too long 203
 - vertical dark streaks on output when scanning from the ADF 201
 - scanner
 - cleaning 134
 - Scanner maintenance required, use ADF Kit 166
 - scanning
 - to an FTP server 47

- scanning quality problem 201
- scanning to a computer 48
- scanning to a flash drive 47
- scanning to an FTP server
 - using the control panel 47
- scheduling a fax 45
- securing printer memory 129
- security slot
 - locating 128
- selecting a location for the printer 10
- sending a fax
 - scheduled 45
 - using the computer 44
 - using the control panel 44
- sending an e-mail 37
- setting the paper size 23
- setting the paper type 23
- setting the Universal paper size 23
- setting up e-mail function 37
- setting up fax
 - country- or region-specific 41
 - standard telephone line connection 39
- setting up fax function 39
- shipping the printer 149
- Shortcut Center
 - using 17
- shortcuts, creating
 - copy screen 36
 - FTP address 47
- showing icons on the home screen 17
- skewed print 185
- Sleep mode
 - configuring 149
- speaker
 - default volume 131
- spoken passwords
 - enabling 21
- statement of volatility 129
- storing print jobs 33
- supplies
 - conserving 150
 - supplies status checking 137
 - supplies, ordering
 - imaging unit 137
 - supply notifications
 - configuring 137
 - supported file types 32

- supported flash drives 32
- supported operating systems 209
- supported paper sizes 27
- supported paper types 29
- supported paper weights 29

T

- toner cartridge
 - ordering 137
 - replacing 137
- toner darkness
 - adjusting 196
- trays
 - installing 208
 - loading 23
- troubleshooting
 - cannot open Embedded Web Server 163
 - printer is not responding 195
- troubleshooting, copy
 - partial copies of documents or photos 201
 - poor copy quality 201
 - scanner does not respond 203
 - scanner unit does not close 203
- troubleshooting, fax
 - cannot send faxes 199
 - cannot send or receive faxes 197
 - received fax has poor print quality 200
- troubleshooting, print
 - collated printing does not work 167
 - confidential and other held documents do not print 169
 - envelope seals when printing 166
 - incorrect margins 179
 - jammed pages are not reprinted 168
 - job prints from the wrong tray 196
 - job prints on the wrong paper 196
 - paper frequently jams 168
 - print jobs do not print 171
 - slow printing 170
 - tray linking does not work 167
- troubleshooting, print quality
 - blank or white pages 172
 - crooked or skewed print 185
 - dark print 173
 - fine lines are not printed
 - correctly 175
 - folded or wrinkled paper 176
 - gray background on prints 177
 - horizontal light bands 179
 - light print 180
 - mottled print and dots 182
 - paper curl 183
 - repeating defects 185
 - solid black pages 186
 - text or images cut off 188
 - toner easily rubs off 189
 - vertical dark bands 190
 - vertical dark lines or streaks 192
 - vertical dark streaks with print missing 193
 - vertical light bands 194
 - vertical white lines 194
- troubleshooting, printer options
 - internal option is not detected 165
- troubleshooting, scan
 - cannot scan from a computer 200
 - partial copies of documents or photos 201
 - poor copy quality 201
 - scan job was not successful 202
 - scanner does not respond 203
 - scanner unit does not close 203
 - vertical dark streaks on output when scanning from the ADF 201
- two-sided copying 35

U

- unable to read flash drive
 - troubleshooting, print 164
- Universal paper size
 - setting 23
- unlinking trays 26
- updating firmware
 - flash file 211
- USB port 12
 - enabling 164

USB printer port 12
using Display Customization 18
using the ADF
 copying 35
using the control panel 14
using the home screen 15
using the keyboard on the
display 22
using the scanner glass
 copying 35

V

verify print jobs 33
vertical dark lines on prints 192
vertical dark streaks on output
when scanning from the
ADF 201
vertical streaks on prints 192
viewing a fax log 46
Voice Guidance
 activating 21
 speech rate 21
Voice Guidance speech rate
 adjusting 21
volatile memory 129
 erasing 128

W

white lines 194
white pages 172
Wireless menu 100
wireless network
 connecting the printer to 131
 Wi-Fi Protected Setup 132
wireless networking 131
Wi-Fi network
 deactivating 132
Wi-Fi Protected Setup
 wireless network 132
wrinkled paper 176